

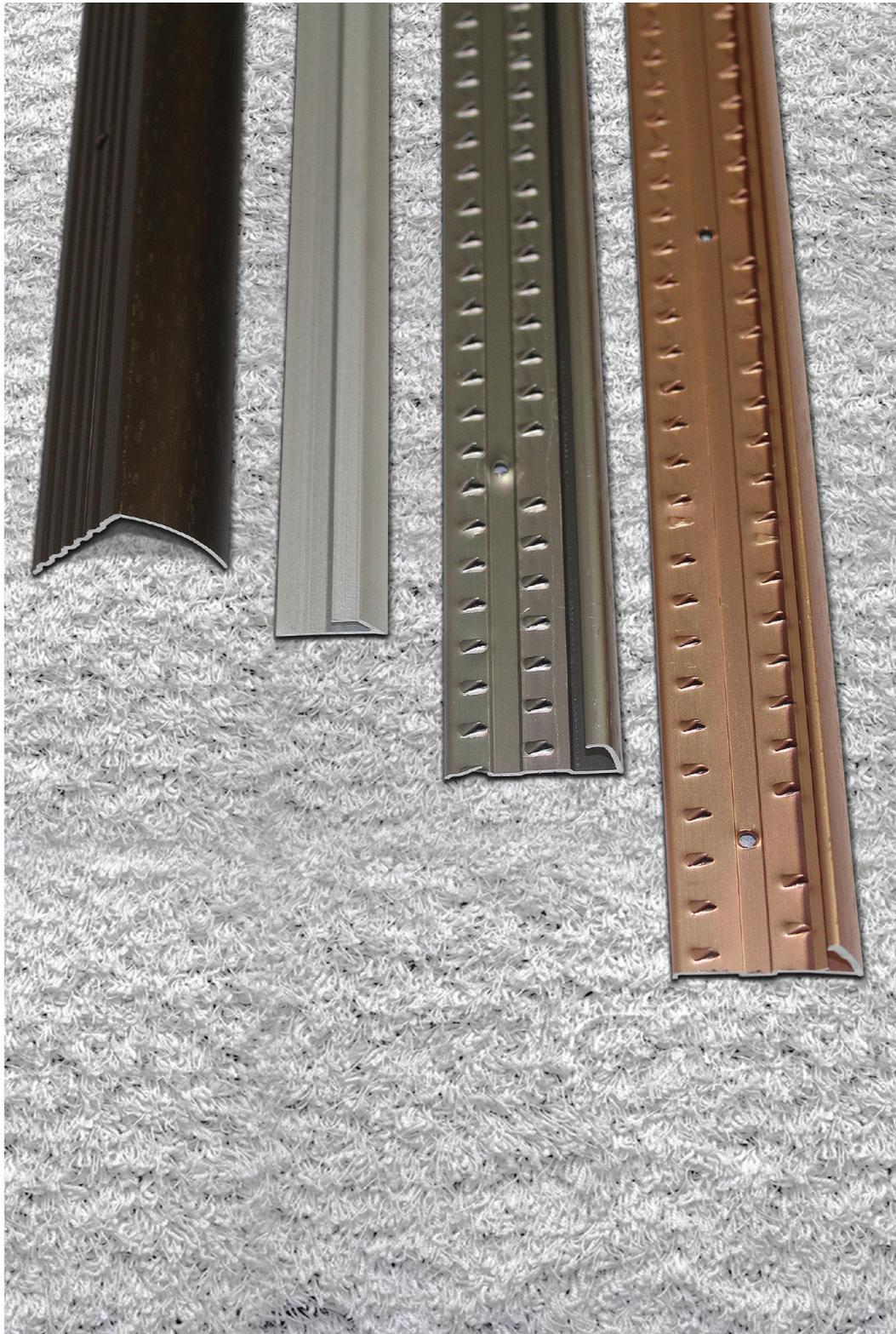

# CARPET METAL & SPECIALTY ACCESSORIES

Product Catalog 2022





The information in this catalog is gathered from customers, end users, and our personal experiences. The products have been created to provide you with solutions for today's transition challenges.

We would like to thank you for your patronage and for giving us the opportunity to become "Your Flooring Accessories Specialist". Being "Your Flooring Accessories Specialist" means ...

- We will provide the best service in the industry by utilizing a team of dedicated Customer Service Specialists.
- Our product will maintain a high degree of consistency and quality to meet the needs of our customers, by manufacturing our product to ISO standards.
- We will incorporate our customers input when making decisions, by using ideas and suggestions brought to us.
- All our business dealings will be handled with integrity, by ensuring customers and suppliers alike know the facts.
- New product innovation will be an integral part of our business strategy, by continually anticipating market trends and designing the accessories demanded by the industry.

For questions or concerns pertaining to products contained in this catalog, please contact our Customer Service department. Our team of specialists will be happy to assist you.

**Toll free:** 1 800 565 6653

**E-mail:** [service@mdteam.com](mailto:service@mdteam.com)

**Website:** [www.mdpro.com](http://www.mdpro.com)

# TABLE OF CONTENTS

## TAP DOWNS

CM14264	Pg.04
CM14266	Pg.04
CM14269	Pg.04
CM14272	Pg.05
CM14273	Pg.05
CM14276	Pg.05
CM17133	Pg.06
CM14259	Pg.06
CM14260	Pg.06
CM14284	Pg.07
CM14296	Pg.07

## BEVEL BARS

CM14256	Pg.07
CM14261	Pg.08
CM14285	Pg.08
CM14265	Pg.08
CM14280	Pg.09
CM14283	Pg.09

## SEAM BINDERS

CM14277	Pg.10
CM14292	Pg.10

## NOSING

CM14257	Pg.11
CM14290	Pg.11
CM14295	Pg.11
CM14262	Pg.12
CM14294	Pg.12
CM14293	Pg.13
CM17352	Pg.13

## THRESHOLDS

CM1144	Pg.14
CM1148	Pg.14

CM14297	Pg.14
WSB4424	Pg.15
WSB4425	Pg.15
WSB4426	Pg.15
WSB4424LP	Pg.15
WSB4425LP	Pg.15
WSB4426LP	Pg.15

## SPECIALTY TRIM

CM14802	Pg.15
CM1122	Pg.16
CM1125	Pg.16
CM1155	Pg.16
CM14281	Pg.17
CM14282	Pg.17
CM14861	Pg.17
CM14289	Pg.18
CM18176	Pg.18
CM99951	Pg.19
CM3220	Pg.19
CM14299	Pg.19
CM14300	Pg.20
CM3210	Pg.20
CM1162	Pg.20
CM1163	Pg.20
CM1164	Pg.20

## CAP TRACK - PINLESS

CM14271	Pg.21
---------	-------

## CAP TRACK - PINNED

CM14270	Pg.21
---------	-------

## LUXURY VINYL FINISHING ESSENTIALS

### LVT FLOOR PROFILES

CM2161	Pg.22
CM2162	Pg.22
LV8903	Pg.22
LV8905	Pg.22
LV8907	Pg.22
LV8303	Pg.23
LV8305	Pg.23
LV8307	Pg.23
LV8503	Pg.23
LV8505	Pg.23
LV8507	Pg.23

### LVT STAIR PROFILES

LV8603	Pg.24
LV8605	Pg.24
LV8607	Pg.24
LV8803	Pg.24
LV8805	Pg.24
LV8807	Pg.24
LV8703	Pg.24
LV8705	Pg.24
LV8707	Pg.24

### LVT MULTI-PURPOSE PROFILES

CM1156	Pg.25
CM1158	Pg.25

### M-D MULTI-FLOOR

MD8010GRY20	Pg.26
-------------	-------

### ALUMINUM FINISHES

.....	Pg.27
-------	-------

### POLICY AND WARRANTY

.....	Pg.28
-------	-------

# CARPET METAL & SPECIALTY TRIM

M-D PRO's traditional line of carpet metal and specialty trim was designed to provide products that aid in unique and detail oriented installations.

This tried and true program has been honed and fine tuned over decades of countless installations and experience. These can include applications such as counters, mirrors/glass, fireplaces, and wheelchair accessible ramps. No matter what the situation is, M-D PRO can provide the item to finish the job with functionality and flare.



# TAPDOWNS

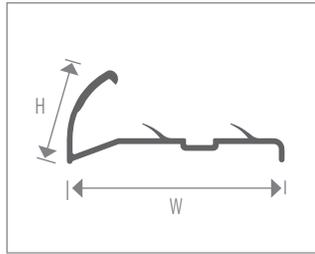

## CM14264

Extra heavy duty pinned Tapdown for use with the thickest action backed carpets. Ultra Pin system for maximum holding strength. 3/4" top face.

LENGTH: 12 FT | PACK SIZE: 42 PCS  
AVAILABLE IN FLEX (CONTOUR) : 12 PCS 

Profile Number	Dimensions	Finishes			
		CVG	HGA	HSI	HTI

CM14264	H=3/4", W=1-5/8"	.	.	.	.
---------	------------------	---	---	---	---

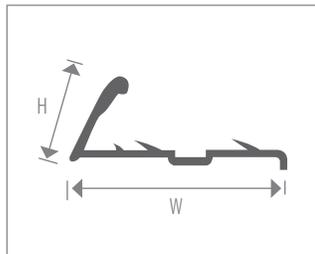

## CM14266

Straight face pinned Tapdown for use with action back carpet. Extra thick face insures long lasting quality installation.

**ADA compliant after install.\***

LENGTH: 12 FT | PACK SIZE: 42 PCS  
AVAILABLE IN FLEX (CONTOUR) : 12 PCS 

Profile Number	Dimensions	Finishes			
		HGA	HSI	HTI	KHG

*  CM14266	H=5/8", W=1-3/8"	.	.	.	.
---	------------------	---	---	---	---

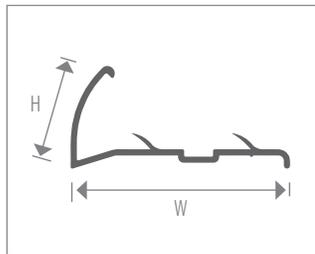

## CM14269

Economy large lip (3/4") Tapdown for use with the thickest action backed carpet. May be used in areas of low traffic. 14269 has the same Ultra Pin system as our other pinned metals for maximum holding strength.

LENGTH: 12 FT | PACK SIZE: 42 PCS  
AVAILABLE IN FLEX (CONTOUR) : 12 PCS 

Profile Number	Dimensions	Finishes					
		CVG	HAB	HCR	HGA	HSI	HTI

CM14269	H=3/4", W=1-1/2"	.	.	.	.	.	.
---------	------------------	---	---	---	---	---	---

\*  Denotes ADA Compliant Profiles

# TAPDOWNS

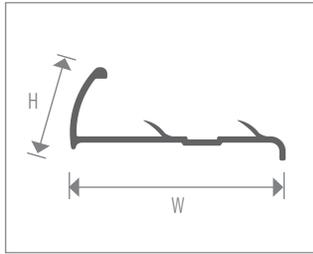

## CM14272

Residential weight pinned Tapdown with additional top return to lock in carpet. For use with low to medium pile action backed carpet up to 30 oz. Ultra Pin system for maximum holding strength.

**ADA compliant after install.\***

LENGTH: 12 FT | PACK SIZE: 42 PCS  
AVAILABLE IN FLEX (CONTOUR) : 12 PCS

Profile Number	Dimensions	Finishes			
		HAB	HGA	HSI	HTI

\* CM14272                      H=9/16", W=1-3/8"                      .                      .                      .                      .

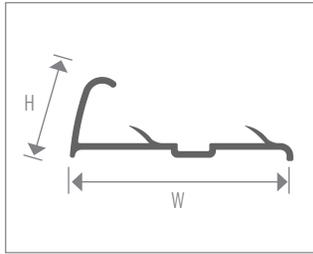
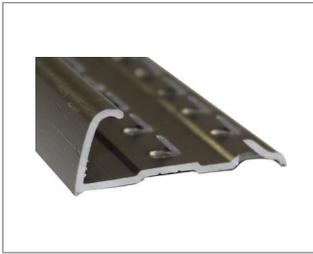

## CM14273

Economy weight pinned Tapdown for use with low pile action backed carpet.

**ADA compliant after install.\***

LENGTH: 12 FT | PACK SIZE: 42 PCS  
AVAILABLE IN FLEX (CONTOUR) : 12 PCS

Profile Number	Dimensions	Finishes				
		CVG	HGA	HSI	HTI	KHG

\* CM14273                      H=1/2", W=1-3/8"                      .                      .                      .                      .                      .

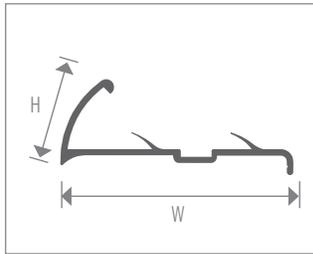

## CM14276

Heavy duty pinned Tapdown for use with high pile action backed carpet up to 60oz. Ultra Pin system for maximum holding strength.

**ADA compliant after install.\***

LENGTH: 12 FT | PACK SIZE: 42 PCS  
AVAILABLE IN FLEX (CONTOUR) : 12 PCS

Profile Number	Dimensions	Finishes				
		CVG	HAB	HGA	HSI	HTI

\* CM14276                      H=5/8", W=1-1/2"                      .                      .                      .                      .                      .

\* Denotes ADA Compliant Profiles

# TAPDOWNS

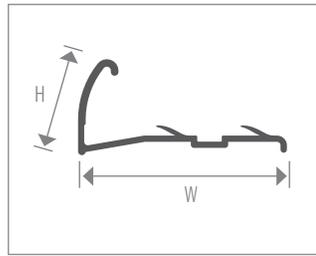

## CM17133

Heavy duty pinned Tapdown used to hold down a very thick stretch of carpet.

**ADA compliant after install.\***

LENGTH: 12 FT | PACK SIZE: 42 PCS

Profile Numbers	Dimensions	Finishes		
		HGA	HSI	HTI
*  CM17133	H=5/64", W=1-11/16"	•	•	•

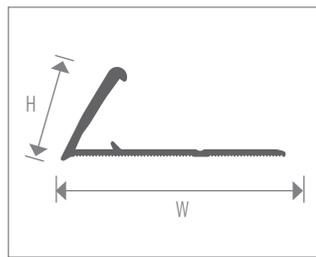

## CM14259

Heavy duty pinless Tapdown for use with rubber backed and direct glue down installations. Nail holes on 12" centres.

**ADA compliant after install.\***

LENGTH: 12 FT | PACK SIZE: 42 PCS

Profile Number	Dimensions	Finishes			
		HGA	HSI	HTI	KHG
*  CM14259	H=5/8", W=1-3/8"	•	•	•	•

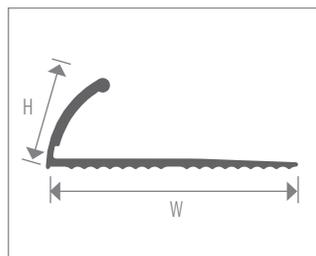
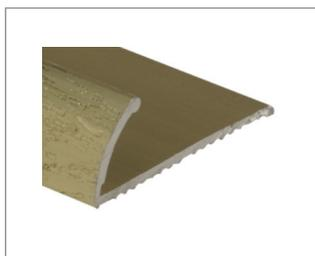

## CM14260

Residential weight Pinless Tapdown for use with foam backed carpet or direct glue down installations.

**ADA compliant after install.\***

LENGTH: 12 FT | PACK SIZE: 42 PCS

Profile Number	Dimensions	Finishes				
		CVG	HAB	HGA	HSI	HTI
*  CM14260	H=1/2", W=1-1/4"	•	•	•	•	•

\*  Denotes ADA Compliant Profiles

## TAPDOWNS

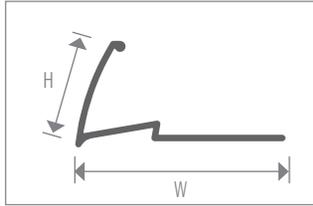
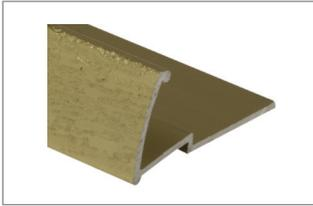

### CM14284

Multi-purpose Tapdown that can be used for carpet underpad installation or glue down installations. The large lip covers even the thickest carpets with room for tucking the edge. Tackless can be used on the bottom for carpet with underpad installations.

LENGTH: 12 FT | PACK SIZE: 42 PCS

Profile Numbers	Dimensions	Finishes			
		HAB	HGA	HSI	HTI
CM14284	H=3/4", W=1-3/8"	.	.	.	.

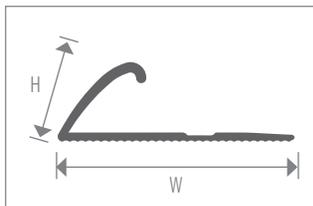

### CM14296

Commercial duty Pinless Tapdown for use in high traffic commercial settings. Used in glue down carpet installations.

LENGTH: 12 FT | PACK SIZE: 12 PCS

Profile Numbers	Dimensions	Finishes
		HSI
CM14296	H=3/4", W=1-7/8"	.

## BEVEL BARS

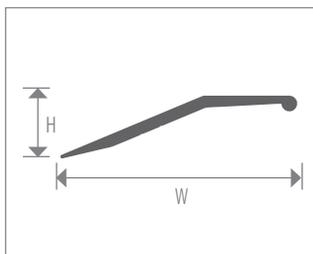

### CM14256

1-1/2" Residential Bevel Bar for transitions. Made for height differentials of up to 3/8".

LENGTH: 12 FT | PACK SIZE: 42 PCS  
METAL DECOR\*: 12 PCS

Profile Numbers	Dimensions	Finishes							
		CVG	DOK*	GOK*	HAB	HCR	HGA	HSI	HTI
 CM14256	H=3/8", W=1-1/2"	.	.	.	.	.	.	.	.

\*  Denotes ADA Compliant Profiles



# BEVEL BARS

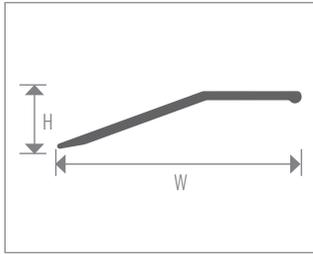
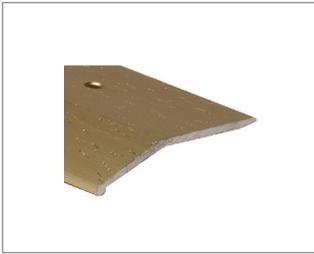

## CM14261

2" Commercial weight Bevel Bar. For use in high traffic areas or where extreme height differentials exist.

LENGTH: 12 FT | PACK SIZE: 12 PCS

Profile Numbers	Dimensions	Finishes		
		HGA	HSI	HTI

**ADA** CM14261

H=3/8", W=2"

.

.

.

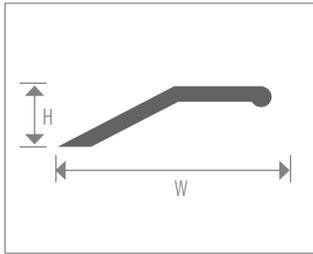

## CM14285

1" Residential Bevel Bar for transitions. Made for height differentials of up to 5/16".

LENGTH: 12 FT | PACK SIZE: 42 PCS

Profile Number	Dimensions	Finishes				
		CVG	HAB	HGA	HSI	HTI

**ADA** CM14285

H=1/4", W=1"

.

.

.

.

.

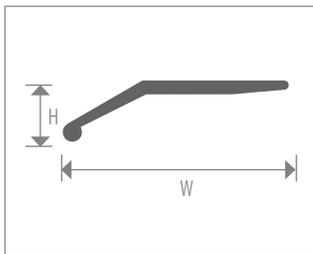

## CM14265

1" Bevel Bar for transitions. Made for height differentials of up to 5/16".

LENGTH: 12 FT | PACK SIZE: 42 PCS

Profile Number	Dimensions	Finishes				
		CVG	HAB	HGA	HSI	HTI

**ADA** CM14265

H=1/4", W=1"

.

.

.

.

.

\* **ADA** Denotes ADA Compliant Profiles

# BEVEL BARS

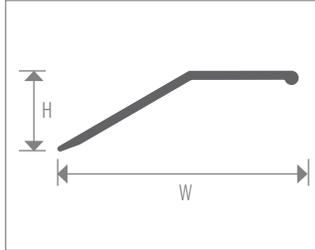

## CM14280

1-1/2" Economy Bevel Bar for transitions. Made for height differentials of up to 3/8".

LENGTH: 12 FT | PACK SIZE: 42 PCS

Profile Numbers	Dimensions	Finishes				
		CVG	HAB	HGA	HSI	HTI
ADA CM14280	H=3/8", W=1-1/2"	.	.	.	.	.

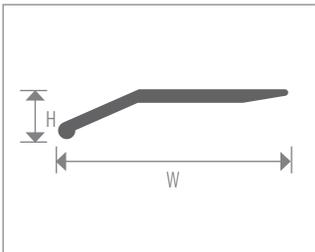

## CM14283

1-1/2" Heavy Duty for heavy traffic application. Made for height differentials of up to 3/8".

LENGTH: 12 FT | PACK SIZE: 42 PCS

Profile Numbers	Dimensions	Finishes		
		HGA	HSI	KHG
ADA CM14283	H=5/16", W=1-1/2"	.	.	.

\* ADA Denotes ADA Compliant Profiles

# SEAM BINDERS

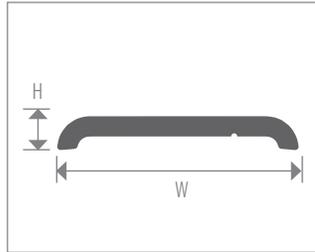

## CM14277

3/4" Seam Binder Covers seams of hard surface or resilient floors.

LENGTH: 12 FT | PACK SIZE: 42 PCS

Profile Numbers	Dimensions	Finishes		
		HGA	HSI	HTI
ADA CM14277	H=1/10", W=3/4"	•	•	•

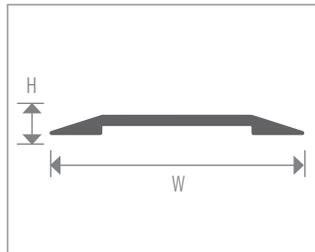

## CM14292

1-1/4" for seams where greater bridging is required.

LENGTH: 12 FT | PACK SIZE: 42 PCS  
METAL DECOR\*: 12 PCS

Profile Numbers	Dimensions	Finishes					
		CVG	GOK*	HAB	HGA	HSI	HTI
ADA CM14292	H=1/10", W=1-1/4"	•	•	•	•	•	•

\* ADA Denotes ADA Compliant Profiles

# NOSING

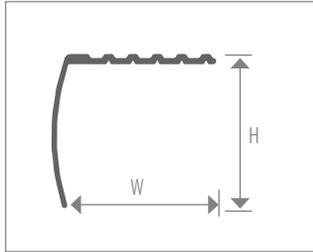
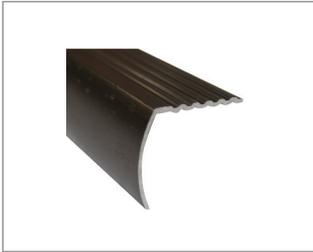

## CM14257

1-1/8" Drop Stair Nosing. Protects edge of stair from damage. This product is designed for light commercial or residential use.

LENGTH: 12 FT | PACK SIZE: 42 PCS  
METAL DECOR\*: 12 PCS

Profile Numbers	Dimensions	Finishes							
		CVG	DOK*	GOK*	HAB	HGA	HSI	HTI	KHG
ADA CM14257	H=1-1/8", W=1-1/8"	.	.	.	.	.	.	.	.

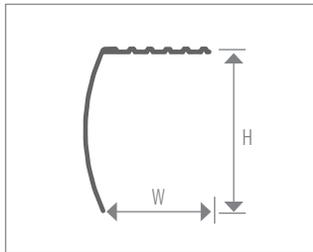

## CM14290

1-5/8" Drop Stair Nosing. Protects edge of stair from damage. This product is designed for light commercial or residential use.

LENGTH: 12 FT | PACK SIZE: 12 PCS

Profile Numbers	Dimensions	Finishes						
		CVG	HAB	HCR	HGA	HSI	HTI	KHG
ADA CM14290	H=1-5/8", W=1-1/8"	.	.	.	.	.	.	.

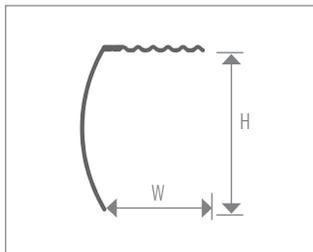

## CM14295

Full 2" Drop Stair Nosing. Protects edge of stair from damage. This product is designed for light commercial or residential use.

LENGTH: 12 FT | PACK SIZE: 12 PCS

Profile Numbers	Dimensions	Finishes		
		HGA	HSI	HTI
ADA CM14295	H=2", W=1-1/4"	.	.	.

\* ADA Denotes ADA Compliant Profiles

# NOSING

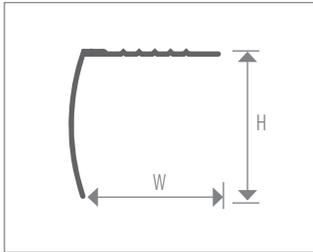

## CM14262

1-1/8" Drop Stair Nosing. Protects edge of stair from damage. This product is designed for light commercial or residential use.

LENGTH: 12 FT | PACK SIZE: 12 PCS

Profile Number	Dimensions	Finishes				
		CVG	HAB	HGA	HSI	HTI

CM14262

H=1-1/8", W=1-1/8"

• • • • •

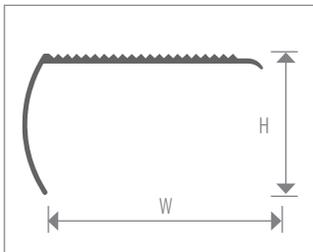

## CM14294

1-1/2" Drop X 2-1/2" Tread Stair Nosing. Provides excellent traction and protection at edge of stair. Ideal for repairing stairs where existing nosing has worn out. Designed for commercial use.

Available in **Drilled Staggered (DS)** or **Drilled Center (DC)**.

LENGTH: 12 FT | PACK SIZE: 12 PCS

Profile Numbers	Dimensions	Finishes			
		BCL	HSI	HTI	SGA

CM14294

H=1-1/2", W= 2-1/2"

• • • •

\* Denotes ADA Compliant Profiles

# NOSING

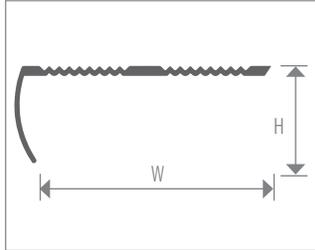

## CM14293

1-3/16" Drop X 3-3/16" Tread Stair Nosing. Provides excellent traction and protection at edge of stair. Ideal for repairing stairs where existing nosing has worn out. Designed for commercial use.

Available in **Drilled Staggered (DS)** or **Drilled Center (DC)**.

LENGTH: 12 FT | PACK SIZE: 12 PCS

Profile Numbers	Dimensions	Finishes	
		BCL	SGA
CM14293	H=1-3/16", W=3-1/16"	•	•

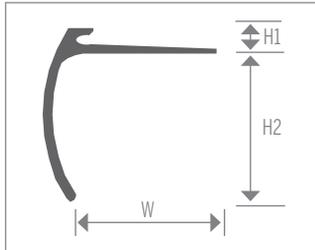

## CM17352

Scribe to Nosing for 1/8" VCT or resilient floors of similar thicknesses. 1-5/8" inside drop to work in most settings. With adhesive reservoir for clean and easy installation.

LENGTH: 12 FT | PACK SIZE: 12 PCS

Profile Numbers	Dimensions	Finishes	
		SCA	STI
 CM17352	H1=1/8", H2=1-5/8", W=1-3/16"	•	•

\*  Denotes ADA Compliant Profiles

# THRESHOLDS

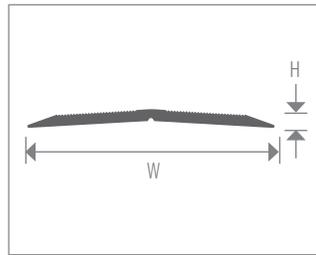

## CM1144

Ribbed threshold for use in joining large gaps. Can also be used as an expansion joint cover. Suitable where low profile or wheelchair access is required. Available in **Drilled Staggered (DS)** or **Drilled Center (DC)**.

LENGTH: 12 FT | PACK SIZE: 12 PCS

Profile Numbers	Dimensions	Finishes
		MIL

CM1144

H=3/16", W=2-1/2"

•

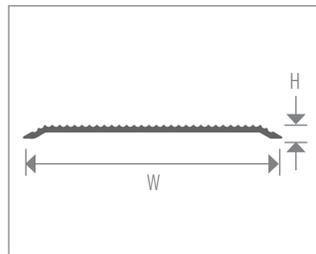

## CM1148

Ribbed threshold for use in joining large gaps. Can also be used as an expansion joint cover. Available in **Drilled Staggered (DS)** or **Drilled Center (DC)**.

LENGTH: 12 FT | PACK SIZE: 12 PCS

Profile Numbers	Dimensions	Finishes
		MIL

CM1148

H=1/8", W=4"

•

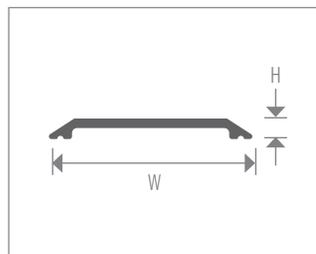

## CM14297

Smooth-top threshold for use in joining large gaps. Can also be used as an expansion joint cover. Suitable for high traffic areas. Available in **Drilled Staggered (DS)** or **Drilled Center (DC)**.

LENGTH: 12 FT | PACK SIZE: 12 PCS

Profile Numbers	Dimensions	Finishes
		MIL

CM14297

H=1/4", W=2-1/2"

•

\* Denotes ADA Compliant Profiles

# THRESHOLDS

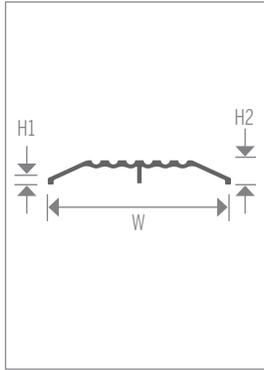

## WS4424/4425/4426

Barrier Free quality extruded Aluminum Thresholds designed for use in commercial applications. Support bars built for added strength.

Full 1/2" height for retrofit situations. 1/4" low profile (LP) height.

Construction Materials Board (CMB) listed material.

- Thresholds come drilled center line, staggered, or undrilled.
- **Thresholds shown meet requirements of ADA, CAN/CSA-B651 and ADMG-1992.**

Available in **Drilled Staggered (DS)** or **Drilled Center (DC)**.

LENGTH: 12 FT | PACK SIZE: 5 PCS

Profile Numbers	Dimensions	Finishes	
		HSI	HTI
ADA WSB4424	H1=1/8", H2=1/2", W=4"	•	•
ADA WSB4425	H1=1/8", H2=1/2", W=5"	•	•
ADA WSB4426	H1=1/8", H2=1/2", W=6"	•	•
ADA WSB4424LP	H1=1/8", H2=1/4", W=4"	•	•
ADA WSB4425LP	H1=1/8", H2=1/4", W=5"	•	•
ADA WSB4426LP	H1=1/8", H2=1/4", W=6"	•	•

# SPECIALTY TRIM

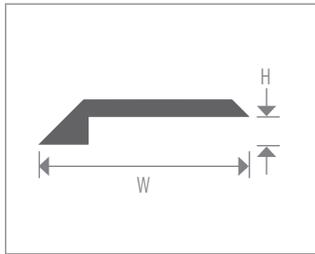

## CM14802

Tile Edge Cap for Finishing the edge of tile or resilient floor. Accommodates materials from 0.080" up to 1/8" thick.

LENGTH: 12 FT | PACK SIZE: 42 PCS

Profile Numbers	Dimensions	Finishes	
		HSI	HTI
ADA CM14802	H=1/10", W=3/4"	•	•

\* ADA Denotes ADA Compliant Profiles



# SPECIALTY TRIM

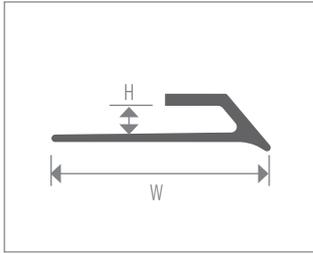

## CM1122

Resilient Flooring Cap. Used when coving sheet goods up the wall to finish off the exposed edge. For materials up to 2.5mm (1/10") or 3.2mm (1/8") thick.

LENGTH: 12 FT | PACK SIZE: 12 PCS

Profile Numbers	Dimensions	Finishes
		SCA

**ADA** CM1122

H=1/10", W=15/16"

•

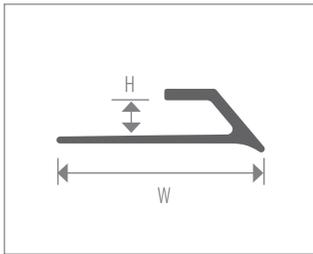
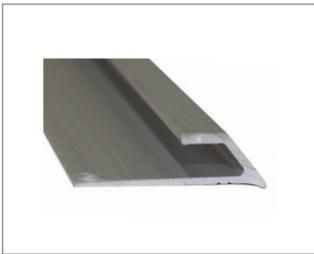

## CM1125

Resilient Flooring Cap. Used when coving sheet goods up the wall to finish off the exposed edge. For materials up to 2.5mm (1/10") or 3.2mm (1/8") thick.

LENGTH: 12 FT | PACK SIZE: 12 PCS

Profile Numbers	Dimensions	Finishes
		SCA

**ADA** CM1125

H=1/8", W=15/16"

•

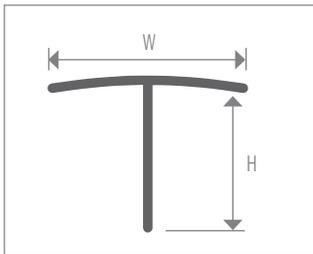

## CM1155

7/8" wide Hatch Cover molding. Used to cover gaps in the floor where hatch covers are installed.

LENGTH: 12 FT | PACK SIZE: 12 PCS

Profile Numbers	Dimensions	Finishes		
		MIL	SCA	STI

**ADA** CM1155

H=5/8", W=7/8"

•

•

•

\* **ADA** Denotes ADA Compliant Profiles

# SPECIALTY TRIM

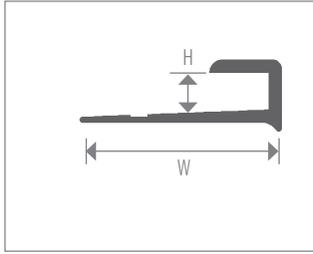

## CM14281

1/4" face cap trim for 1/8" material.

LENGTH: 8FT, 12 FT | PACK SIZE: 42 PCS

Profile Numbers	Dimensions	Finishes		
		MIL	SCA	STI
ADA CM14281	H=1/8", W=3/4"	.	.	.

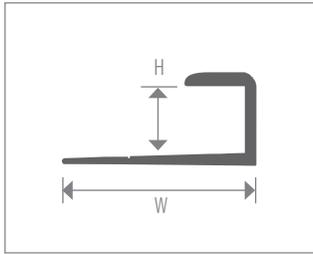

## CM14282

9/32" face cap trim for 1/4" material.

LENGTH: 12 FT | PACK SIZE: 12 PCS

Profile Numbers	Dimensions	Finishes	
		SCA	SGA
CM14282	H=1/4", W=3/4"	.	.

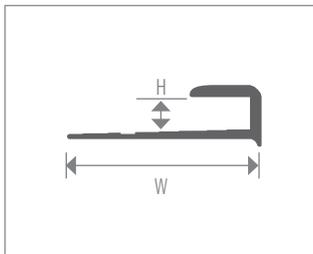
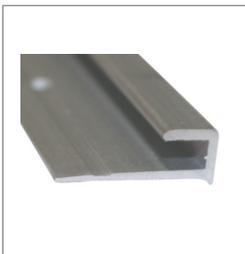

## CM14861

Small face cap trim for 1/10" material.

LENGTH: 12 FT | PACK SIZE: 40 PCS

Profile Numbers	Dimensions	Finishes
		SCA
ADA CM14861	H=1/10", W=13/16"	.

\* ADA Denotes ADA Compliant Profiles

# SPECIALTY TRIM

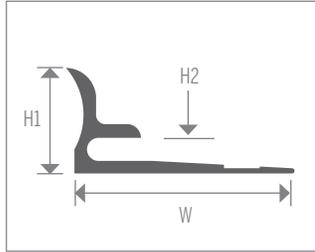
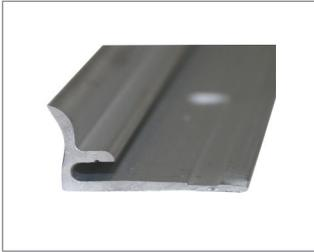

## CM14289

1/16" insert cove for laminate material.

LENGTH: 12 FT | PACK SIZE: 42 PCS

Profile Numbers	Dimensions	Finishes	
		MIL	SCA
CM14289	H1=3/8", H2=1/16", W=3/4"	•	

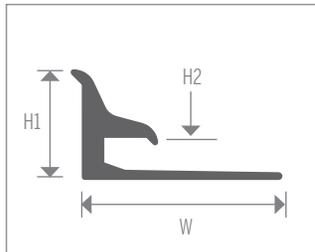

## CM18176

1/10" insert cove for resilient sheet goods up to 1/10".

LENGTH: 12 FT | PACK SIZE: 40 PCS

Profile Numbers	Dimensions	Finishes	
		MIL	SCA
CM18176	H1=7/16" ,H2=1/10", W=3/4"	•	•

# SPECIALTY TRIM

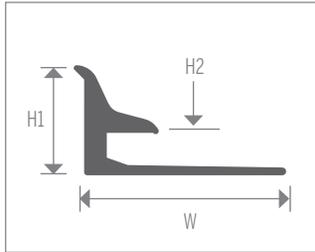
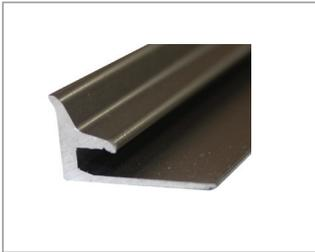

## CM99951

1/8" insert cove for resilient sheet goods up to 1/8".

LENGTH: 12 FT | PACK SIZE: 12 PCS

Profile Numbers	Dimensions	Finishes	
		MIL	SCA

CM99951

H1=7/16", H2=1/8", W=3/4"

•

•

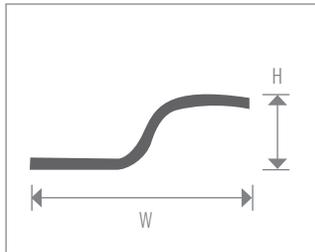

## CM3220

Z-Bar is an offset hearth metal for installing carpet around fireplaces. Provides grip while remaining invisible.

LENGTH: 4 FT | PACK SIZE: 25 PCS

Profile Numbers	Dimensions	Finishes
		MIL

CM3220

H=1/2", W=1-3/16"

•

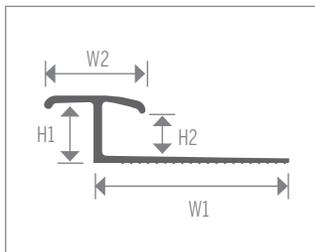

## CM14299

Pinless Divider for commercial use. Used where glue down carpet meets ceramic, hardwood, laminate, cushion floor on plywood or sheet vinyl on subfloor. (Can be adjusted to accept slightly thinner materials). For high traffic areas.

LENGTH: 12 FT | PACK SIZE: 42 PCS

Profile Numbers	Dimensions	Finishes	
		HSI	HTI

ADA CM14299

H1=7/16", H2=5/16", W1=1-7/16", W2=3/4"

•

•

\* ADA Denotes ADA Compliant Profiles

# SPECIALTY TRIM

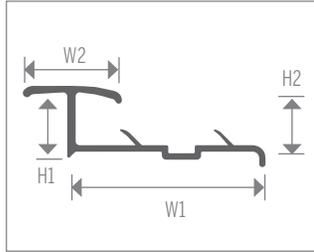
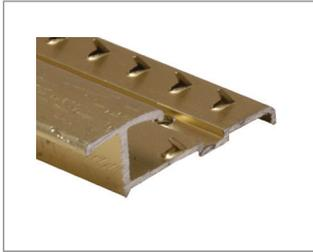

## CM14300

Pinned Divider for commercial use. Used where stretched in carpet meets ceramic, hardwood, laminate, cushion floor on plywood or sheet vinyl on subfloor. (Can be adjusted to accept slightly thinner materials). For high traffic areas.

LENGTH: 12 FT | PACK SIZE: 12 PCS

Profile Numbers	Dimensions	Finishes	
		HGA	HSI

CM14300

H1=7/16", H2=5/16", W1= 1-13/16", W2= 1-1/2"

• •

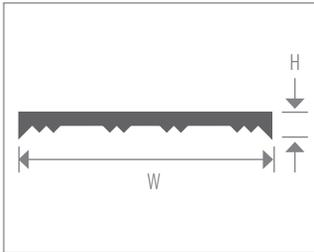

## CM3210

2-1/4" wide **SABRE TOOTH STRAIGHT EDGE**. Grooves prevent tool from moving by biting into carpet. Allows carpet technician to cut carpet up to 12 feet wide. Clear Anodized to prevent marking carpet.

Sizes Available: SE 29" SE 75" SE 36" SE 84" SE 150"

PACK SIZE: 1 PC

Profile Numbers	Dimensions	Finishes
		SCA

CM3210

H=1/4", W=2-1/4"

•

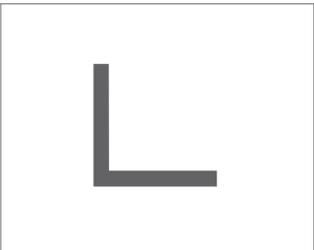

## CM1162/1163/1164

Angle for use on corners to protect edge. Can also be used as an accent. Can be drilled.

LENGTH: 12 FT | PACK SIZE: 25 PCS

Profile Numbers	Dimensions	Finishes		
		BCL	SCA	STI

CM1162

1/2"x 1/2"

• • •

CM1163

3/4"x 3/4"

• • •

CM1164

1"x 1"

• • •

\* Denotes ADA Compliant Profiles

## CAP TRACK - PINLESS

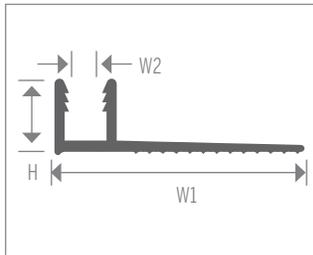

### CM14271

Pinless Channel for use where rubber backed carpet meets dissimilar flooring. Accepts all 3/16" leg "E" or "T" caps.

LENGTH: 12 FT | PACK SIZE: 25 PCS  
 AVAILABLE IN FLEX (CONTOUR) : 12 PCS 

ALSO AVAILABLE WITH PRE-PUNCHED BASE

Profile Numbers	Dimensions	Finishes
		MIL
CM14271	H=3/8", W1=1-1/4", W2=5/32"	•

## CAP TRACK - PINNED

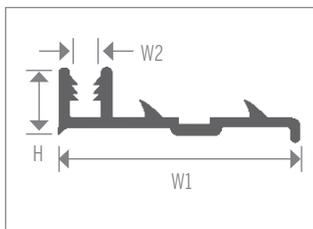

### CM14270

Pinned Channel for use where action backed carpet meets dissimilar flooring. Accepts all 3/16" leg "E" or "T" caps.

LENGTH: 12 FT | PACK SIZE: 25 PCS  
 AVAILABLE IN FLEX (CONTOUR) : 12 PCS 

Profile Numbers	Dimensions	Finishes
		MIL
CM14270	H=3/8", W1=1-7/16", W2=5/32"	•

# LUXURY VINYL FINISHING ESSENTIALS

The **M-D PRO** line of luxury vinyl transitions and finishing accessories provide versatility and function for the most common LVT/LVP applications. Providing these **ESSENTIAL profiles** allows you to consolidate inventory while satisfying customer needs.

- **All Floor and Stair profiles can accommodate flooring material up to 7mm thick!**
- **New sizes provide versatility and range for flooring material thickness**
- **Universal 3/8" top lip accepts both floating and glue down applications**
- **Rounded corner edge for smooth and safe transition**
- **Durable, anodized finishes complement today's most popular flooring styles**
- **Reduce SKU count and stock these ESSENTIALS today!**

## LVT FLOOR PROFILES

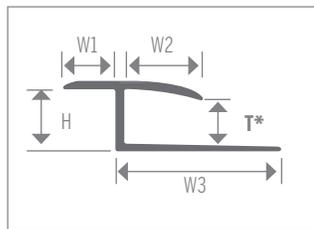

### LVT TO CARPET

LVT to Carpet transition for use where Luxury Vinyl Tile or Plank Flooring meets low pile carpet or other flooring material.

LENGTH: 12 FT | PACK SIZE: 12 PCS

\*(T) APPLICATION THICKNESS

Profile Number	Dimensions	Finishes		
		SCA	SAB	STI
LV8903	T=5/64" - 1/8" (2mm - 3mm), H=1/4" (6.5mm), W1=1/4" (6.5mm), W2=3/8" (10mm), W3=3/4" (19mm)	•	•	•
LV8905	T=5/32" - 13/64" (4mm - 5mm), H=1/4" (6.5mm), W1=1/4" (6.5mm), W2=3/8" (10mm), W3=3/4" (19mm)	•	•	•
LV8907	T=15/64" - 9/32" (6mm - 7mm), H=1/4" (6.5mm), W1=1/4" (6.5mm), W2=3/8" (10mm), W3=3/4" (19mm)	•	•	•

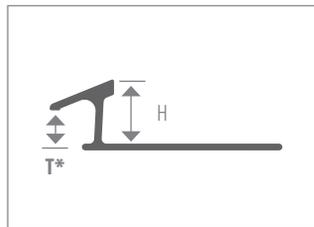

### LVT TO TILE ADAPTER

LVT to Tile Adapter for use where tile meets existing Luxury Vinyl Tile or Plank Flooring up to 1/4" (6.5mm) thick.

LENGTH: 8 FT | PACK SIZE: 12 PCS

\*(T) APPLICATION THICKNESS

Profile Number	Dimensions	Finishes									
		BBR	BCL	MIL	SAB	SBK	SCA	SCP	SDB	SGA	STI
CM2161	T=1/4" (6.5mm), H=3/8" (10mm)	•	•	•	•	•	•	•	•	•	•
CM2162	T=1/4" (6.5mm), H=1/2" (12.5mm)	•	•	•	•	•	•	•	•	•	•

## LVT FLOOR PROFILES

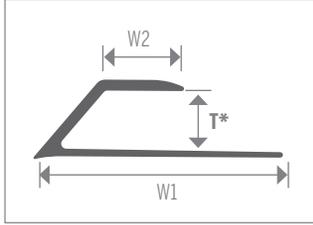

### REDUCER

Reducer for use with Luxury Vinyl Tile or Plank Flooring.

LENGTH: 12 FT | PACK SIZE: 12 PCS

\*(T) APPLICATION THICKNESS

Profile Numbers	Dimensions	Finishes		
		SAB	SCA	STI
ADA LV8303	T=5/64" - 1/8" (2mm - 3mm), W1=1" (25mm), W2=3/8" (10mm)	•	•	•
ADA LV8305	T=5/32" - 13/64" (4mm - 5mm), W1=1" (25mm), W2=3/8" (10mm)	•	•	•
ADA LV8307	T=15/64" - 9/32" (6mm - 7mm), W1=1" (25mm), W2=3/8" (10mm)	•	•	•

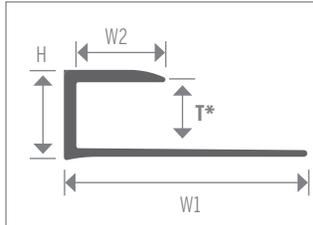

### J-MOLDING

J-Molding/End Cap for use with Luxury Vinyl Tile or Plank Flooring.

LENGTH: 12 FT | PACK SIZE: 12 PCS

\*(T) APPLICATION THICKNESS

Profile Numbers	Dimensions	Finishes		
		SAB	SCA	STI
ADA LV8503	T=5/64" - 1/8" (2mm - 3mm), H=15/64" (6mm), W1=1" (25mm), W2=3/8" (10mm)	•	•	•
ADA LV8505	T=5/32" - 13/64" (4mm - 5mm), H=19/64" (7.5mm), W1=1" (25mm), W2=3/8" (10mm)	•	•	•
ADA LV8507	T=15/64" - 9/32" (6mm - 7mm), H=3/8" (10mm), W1=1" (25mm), W2=3/8" (10mm)	•	•	•

\* ADA Denotes ADA Compliant Profiles



# LVT STAIR PROFILES

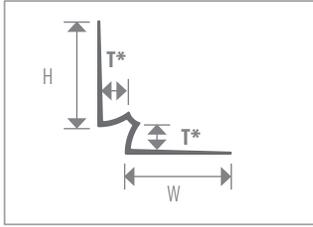

## INSIDE COVE

Inside Cove for use with Luxury Vinyl Tile or Plank Flooring. Typically used to finish corners of stair tread-to-riser applications. Avoid dirt build-up in riser corners.

LENGTH: 12 FT | PACK SIZE: 12 PCS

\*(T) APPLICATION THICKNESS

Profile Numbers	Dimensions	Finishes		
		SAB	SCA	STI
LV8603	T=5/64" - 1/8" (2mm - 3mm), H/W=1" (25mm)	•	•	•
LV8605	T=5/32" - 13/64" (4mm - 5mm), H/W=1" (25mm)	•	•	•
LV8607	T=15/64" - 9/32" (6mm - 7mm), H/W=1" (25mm)	•	•	•

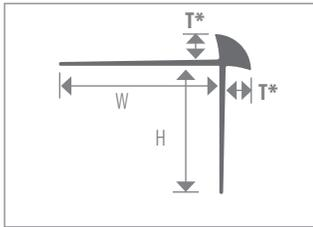

## OUTSIDE CORNER SQUARE STAIR NOSE

Outside Corner Square Stair Nosing for use with Luxury Vinyl Tile or Plank Flooring. Minimal reveal outside corner edge provides clean finish.

LENGTH: 12 FT | PACK SIZE: 12 PCS

\*(T) APPLICATION THICKNESS

Profile Numbers	Dimensions	Finishes		
		SAB	SCA	STI
LV8803	T=5/64" - 1/8" (2mm - 3mm), H=1" (25mm), W=1-1/4" (32mm)	•	•	•
LV8805	T=5/32" - 13/64" (4mm - 5mm), H=1" (25mm), W=1-1/4" (32mm)	•	•	•
LV8807	T=15/64" - 9/32" (6mm - 7mm), H=1" (25mm), W=1-1/4" (32mm)	•	•	•

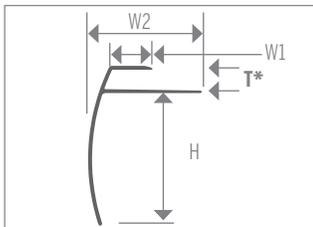

## STAIR NOSING

Stair Nosing for use with Luxury Vinyl Tile or Plank Flooring.

LENGTH: 12 FT | PACK SIZE: 12 PCS

\*(T) APPLICATION THICKNESS

Profile Numbers	Dimensions	Finishes		
		SAB	SCA	STI
LV8703	T=5/64" - 1/8" (2mm - 3mm), H=1-7/8" (47.5mm), W1=3/8" (10mm), W2=1-5/8" (41mm)	•	•	•
LV8705	T=5/32" - 13/64" (4mm - 5mm), H=1-7/8" (47.5mm), W1=3/8" (10mm), W2=1-5/8" (41mm)	•	•	•
LV8707	T=15/64" - 9/32" (6mm - 7mm), H=1-7/8" (47.5mm), W1=3/8" (10mm), W2=1-5/8" (41mm)	•	•	•

# LVT MULTI-PURPOSE PROFILES

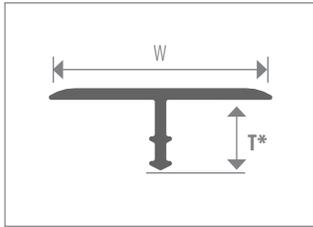

## EXPANSION JOINT

Expansion Joint for use between Luxury Vinyl Tile/Plank Flooring and other flooring materials of equal heights where expansion is expected.

LENGTH: 8 FT | PACK SIZE: 12 PCS

\*(T) APPLICATION THICKNESS

Profile Number	Dimensions	Finishes								
		BBR	BCL	MIL	SBK	SCA	SCP	SDB	SGA	STI

ADA CM1156

T=5/16" (8mm), W=7/8" (22mm)

• • • • • • • • • •

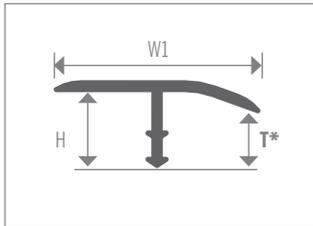

## JOINT REDUCER

Joint Reducer for use between Luxury Vinyl Tile/Plank Flooring and other flooring materials of different heights where expansions is expected.

LENGTH: 8 FT | PACK SIZE: 12 PCS

\*(T) APPLICATION THICKNESS

Profile Numbers	Dimensions	Finishes	
		SCA	STI

ADA CM1158

T=13/64" - 9/32" (5mm - 7mm), H=5/16" - 3/8" (8mm - 10mm), W=7/8" (22mm)

• •

\* ADA Denotes ADA Compliant Profiles

## M-D MULTI-FLOOR®



### MULTI-FLOOR®

The M-D MULTI-FLOOR® underlayment system provides advanced durability & protection for ALL floating floor applications! The versatile underlayment is suitable for multiple areas of application and substrates. Exclusive elastic spring technology allows for dynamic contraction, delivering a durable and comfortable walking surface for years to come. With the ability to be used under all floating floor surface materials (hardwood, laminate, LVT/LVP, and carpet), M-D MULTI-FLOOR® is the ultimate solution for the most common flooring applications!

PACK SIZE: 1 ROLL

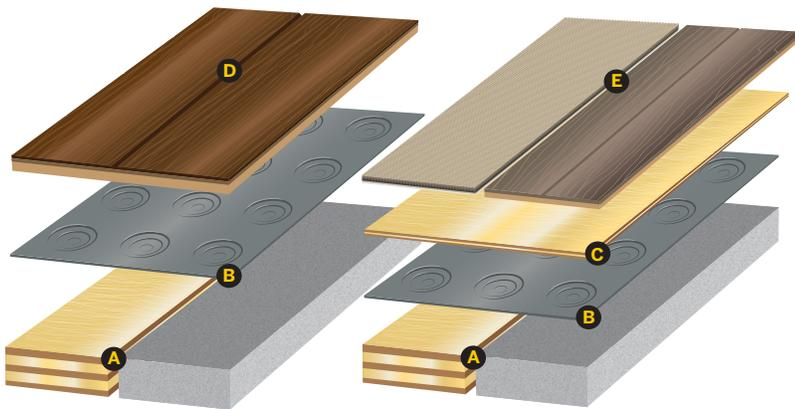

A. Concrete or plywood substrate

B.  MULTI-FLOOR®

C. 5/8" (16 mm) tongue-and-groove plywood

D. Hardwood or laminate

E. LVT/LVP or carpet

Profile Number	Dimensions	Color
----------------	------------	-------

MD8010GRY20

215 sq.ft (20 m) roll

Grey



### M-D MULTI-FLOOR® SEALING TAPE

Tape designed to seal all joints between sections of M-D MULTI-FLOOR® underlayment. The tape resists moisture and provides premium bonding capabilities.\*

PACK SIZE: 6 ROLLS

Profile Number	Dimensions	Color
----------------	------------	-------

MD8020BLK55

180.4' x 1.9" (55 m x 48 mm)

Black



\* Seal all joints with **M-D MULTI-FLOOR® SEALING TAPE**

**NOTE:** This step is recommended for all applications, but it is required for installations done below grade or on concrete substrates that are above or below grade.

## ALUMINUM FINISHES

(Finishes may not appear exactly as shown. Please request a sample prior to placing an order)



**BCL**  
BRIGHT CLEAR



**CVG**  
COVENTRY GOLD



**DOK\***  
METAL DECOR DARK OAK



**GOK\***  
METAL DECOR GOLDEN OAK

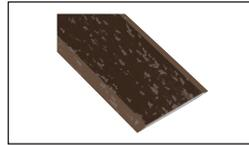

**HAB**  
HAMMERED ANTIQUE BRONZE



**HCR**  
HAMMERED COPPER

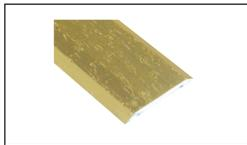

**HGA**  
HAMMERED GOLD ANODIZED



**HSI**  
HAMMERED SILVER

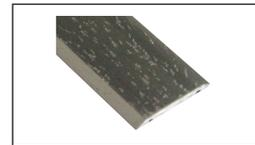

**HTI**  
HAMMERED TITANIUM



**KHG**  
KINTRIM HAMMERED GOLD



**MIL**  
MILL FINISH

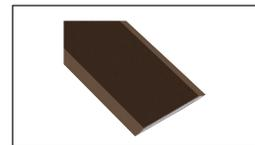

**SAB**  
SATIN ANTIQUE BRONZE

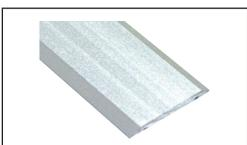

**SCA**  
SATIN CLEAR ANODIZED



**SGA**  
SATIN GOLD ANODIZED



**STI**  
SATIN TITANIUM

**\*\*DISCLAIMER:** DO NOT USE MILL FINISH IN WET AREAS. MILL product is aluminum in its raw state, therefore there is a high risk of oxidization on the product and staining on the flooring material and/or grout when it is used in wet areas.

## **BROKEN CARTON POLICY**

Less than full cartons may be purchased on select items with a minimum up charge of 20%, please contact your Customer Service Representatives for details. No returns will be granted for items that fall below the standard carton/pack size.

## **M-D PRO LIMITED WARRANTY**

M-D PRO products are warranted for a period of 1 (one) year from date of shipment. All products will be subject to the following manufacture warranties; Products will conform to original product and contract description with only such reasonable variations as is acceptable in the trade. These products will be fit for the purposes for which they were intended and that they will be professionally packaged and labeled. M-D PRO will replace any defective product found if said defect is identified before installation. If a defect is found after installation, M-D PRO must be notified in writing within 10 days of installation. The customer must then, at M-D PRO's discretion, allow an inspection of the installation. If upon inspection, M-D PRO determines the product to be defective, M-D Pro will at its own discretion supply replacement materials that conform to the contract requirements or issue a credit equal to but not exceeding the original purchase price for the goods in question. M-D PRO assumes no liability or responsibilities for labor or the cost of other materials used in such installations.

These warranties do not circumvent any individual product category warranties implied or stated by M-D PRO.

Warranties do not apply to the following specified items, terms and conditions:

- A.** Exact matching of color, shade, texturing or mottling.
- B.** Any warranties, other than expressed above, implied or promised by any sales representative.
- C.** Tears, scratches, burns, or other damage caused by improper installation, improper use or maintenance.
- D.** Sales of "Seconds", or "Imperfect" goods.
- E.** Problem caused by moisture, hydrostatic pressure or alkali in the sub-floor.
- F.** Problem caused by installation with non-approved adhesive. If you are unsure about the suitability of a particular adhesive, please call us for our recommendations.
- G.** Product installed outdoors. M-D PRO products are designed for interior use only.
- H.** Color degradation caused by sunlight or other U.V. exposure. These warranties are supplied in lieu of any other warranty, expressed or implied. All product specifications are subject to change without notice.







5720 Ambler Drive  
Mississauga, ON, L4W 2B1  
Telephone: 1 800 565 6653  
E-mail: [service@mdteam.com](mailto:service@mdteam.com)  
Website: [www.mdpro.com](http://www.mdpro.com)

Part #: MPCATMETALLOX  
Print date: May 2022