

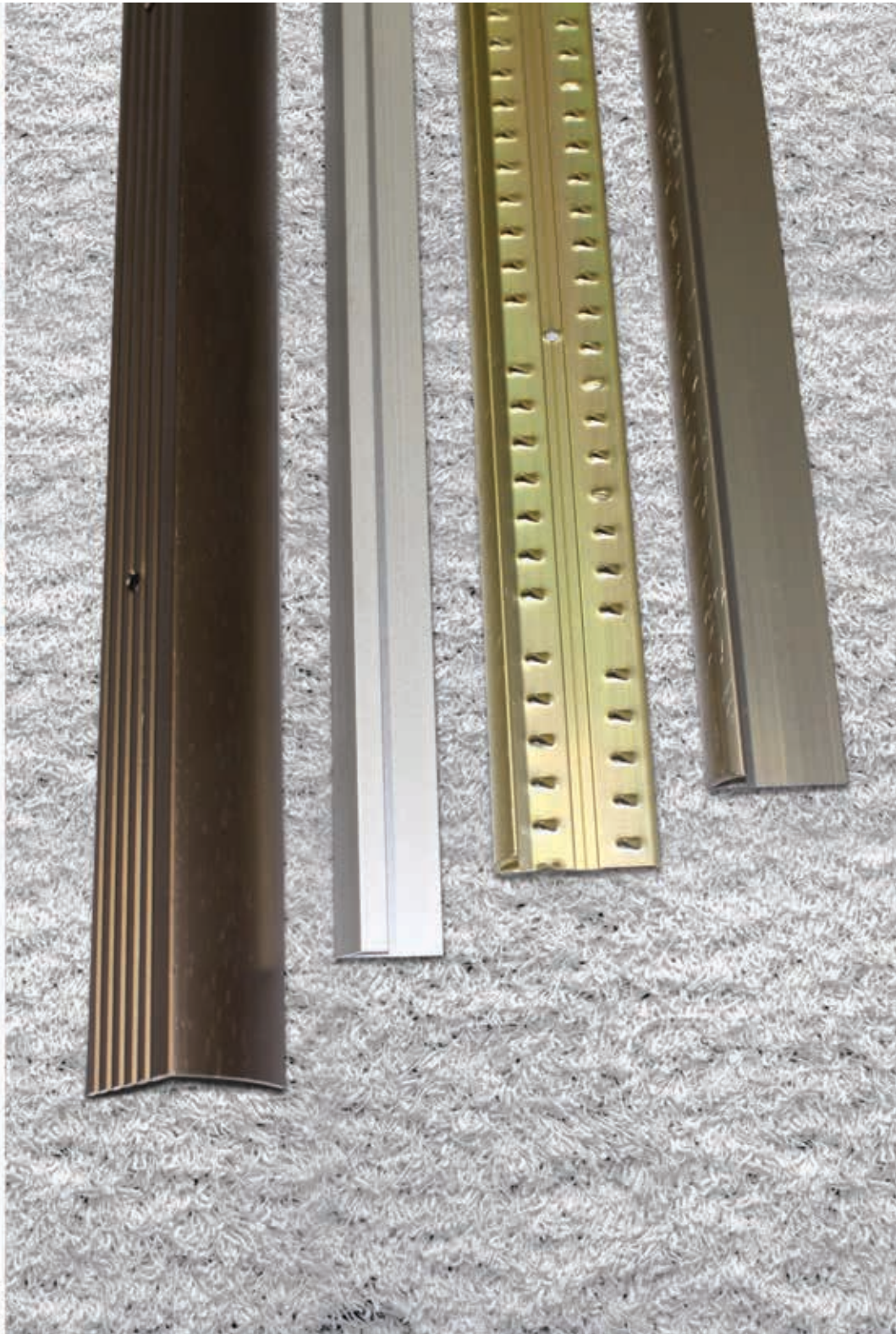

CARPET METAL & SPECIALTY ACCESSORIES

Product Catalog **2022**





The information in this catalog is gathered from customers, end users, and our personal experiences. The products have been created to provide you with solutions for today's transition challenges.

We would like to thank you for your patronage and for giving us the opportunity to become "Your Flooring Accessories Specialist". Being "Your Flooring Accessories Specialist" means ...

- We will provide the best service in the industry by utilizing a team of dedicated Customer Service Specialists.
- Our product will maintain a high degree of consistency and quality to meet the needs of our customers, by manufacturing our product to ISO standards.
- We will incorporate our customers input when making decisions, by using ideas and suggestions brought to us.
- All our business dealings will be handled with integrity, by ensuring customers and suppliers alike know the facts.
- New product innovation will be an integral part of our business strategy, by continually anticipating market trends and designing the accessories demanded by the industry.

For questions or concerns pertaining to products contained in this catalog, please contact our Customer Service department. Our team of specialists will be happy to assist you.

Toll free: 1 800 565 6653

E-mail: service@mdteam.com

Website: www.mdpro.com

TABLE OF CONTENTS

TAP DOWNS

CM1740	Pg.04
CM1741	Pg.04
CM1750	Pg.04
CM1760	Pg.05
CM1770.....	Pg.05
CM1780	Pg.05
CM1621	Pg.05
CM1650	Pg.06
CM1653	Pg.06
CM1657.....	Pg.06

BEVEL BARS

CM1196	Pg.07
CM1197	Pg.07
CM2196	Pg.07
CM2197.....	Pg.07
CM3196	Pg.08

SEAM BINDERS

CM1342	Pg.08
CM1344	Pg.08
CM1142	Pg.09

NOSING

CM2184	Pg.09
CM2190	Pg.09
CM2191	Pg.10
CM2193	Pg.10
CM2199	Pg.10
CM2194	Pg.11
CM2182	Pg.11
CM2195	Pg.11
CM2198	Pg.12
CM2185	Pg.12
CM2192	Pg.12

THRESHOLDS

CM1144.....	Pg.13
CM1145.....	Pg.13
CM1146.....	Pg.14
CM1148.....	Pg.14
WSB4424	Pg.14

WSB4425	Pg.14
WSB4426.....	Pg.14
WSB4424LP.....	Pg.14
WSB4425LP.....	Pg.14
WSB4426LP.....	Pg.14

SPECIALTY

CM1121.....	Pg.15
CM1122.....	Pg.15
CM1125.....	Pg.15
CM1155.....	Pg.16
CM14281.....	Pg.16
CM2130	Pg.16
CM330.....	Pg.17
CM331.....	Pg.17
CM3330.....	Pg.17
CM3340.....	Pg.18
CM3220.....	Pg.18
CM1666	Pg.18
CM1766.....	Pg.19
CM3210	Pg.19
CM1162	Pg.19
CM1163	Pg.19
CM1164.....	Pg.19

CAP TRACK - PINLESS

CM1651.....	Pg.20
CM1655	Pg.20
CM1658	Pg.20
CM1659	Pg.20
CM1660	Pg.20

CAP TRACK - PINNED

CM1751	Pg.21
CM1752.....	Pg.21
CM1755.....	Pg.21
CM1759.....	Pg.21

LUXURY VINYL FINISHING ESSENTIALS

LVT FLOOR PROFILES

CM2161.....	Pg.22
CM2162.....	Pg.22
LV8903.....	Pg.22
LV8905.....	Pg.22
LV8907.....	Pg.22
LV8303.....	Pg.23
LV8305.....	Pg.23
LV8307.....	Pg.23
LV8503.....	Pg.23
LV8505.....	Pg.23
LV8507.....	Pg.23

LVT STAIR PROFILES

LV8603.....	Pg.24
LV8605.....	Pg.24
LV8607.....	Pg.24
LV8803.....	Pg.24
LV8805.....	Pg.24
LV8807.....	Pg.24
LV8703.....	Pg.24
LV8705.....	Pg.24
LV8707.....	Pg.24

LVT MULTI-PURPOSE PROFILES

CM1156.....	Pg.25
CM1158.....	Pg.25

M-D MULTI-FLOOR

MD8010GRY20.....	Pg.26
------------------	-------

ALUMINUM FINISHES

.....	Pg.27
-------	-------

POLICY AND WARRANTY

.....	Pg.28
-------	-------

CARPET METAL & SPECIALTY TRIM

M-D PRO's traditional line of carpet metal and specialty trim was designed to provide products that aid in unique and detail oriented installations.

This tried and true program has been honed and fine tuned over decades of countless installations and experience. These can include applications such as counters, mirrors/glass, fireplaces, and wheelchair accessible ramps. No matter what the situation is, M-D PRO can provide the item to finish the job with functionality and flare.

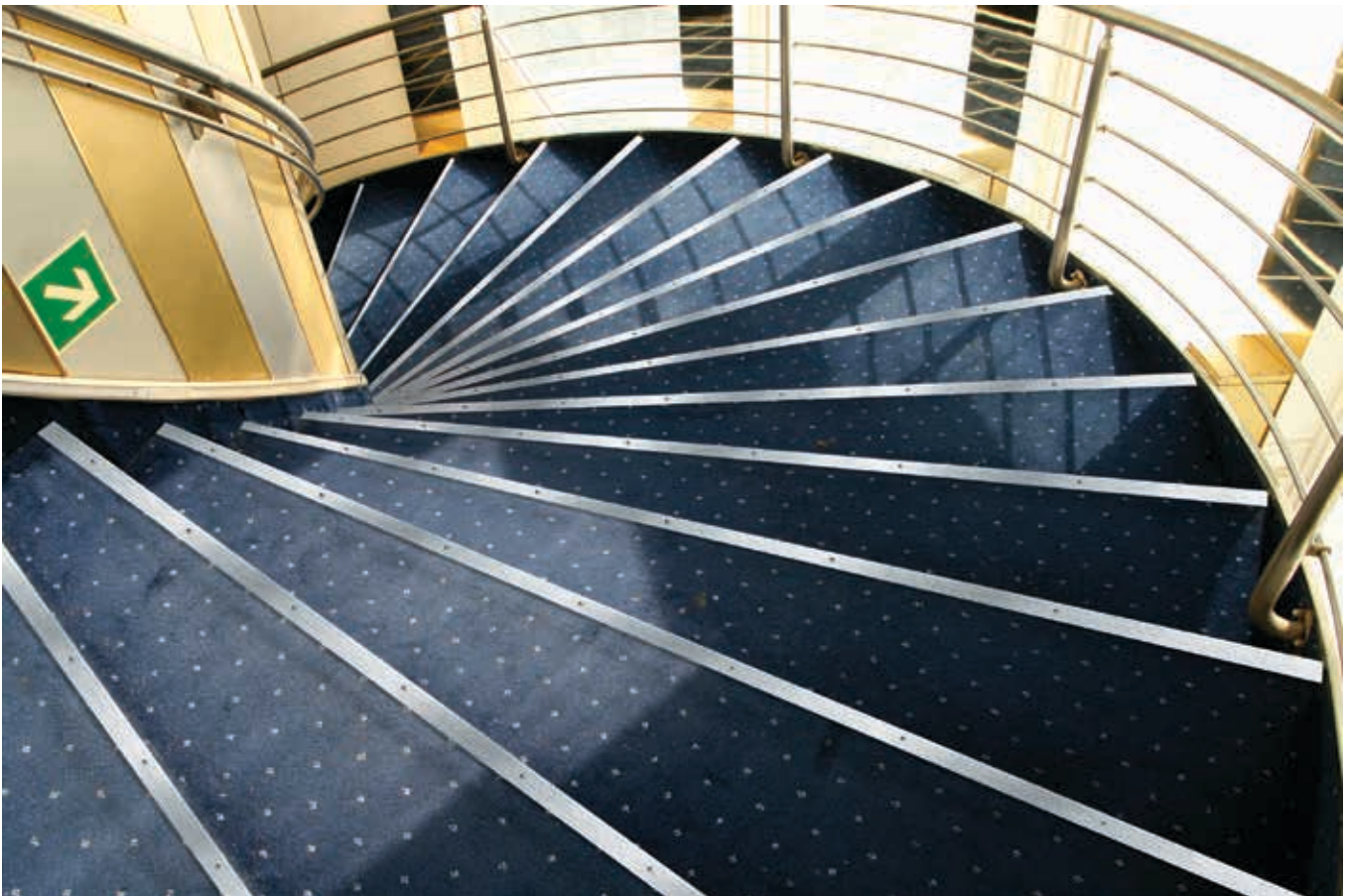

TAPDOWNS

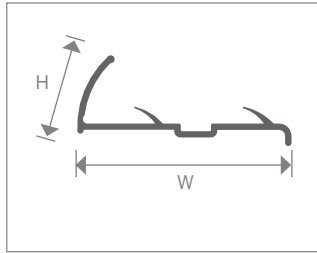

CM1740

Residential weight pinned Tapdown. For use with low to medium pile action backed carpet up to 30 oz. Ultra Pin system for maximum holding strength.

ADA compliant after install.*

LENGTH: 12 FT | PACK SIZE: 42 PCS
AVAILABLE IN FLEX (CONTOUR) : 12 PCS 

Profile Number	Dimensions	Finishes			
		HAB	HGA	HSI	HTI

 CM1740

H=9/16" (14.5mm), W=1-3/8" (35mm)

• • • •

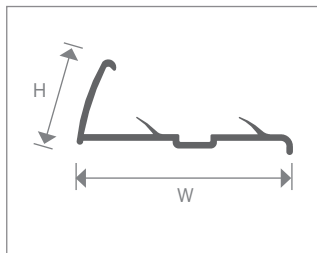

CM1741

Residential weight pinned Tapdown with additional top return to lock in carpet. For use with low to medium pile action backed carpet up to 30 oz. Ultra Pin system for maximum holding strength.

ADA compliant after install.*

LENGTH: 12 FT | PACK SIZE: 42 PCS

Profile Number	Dimensions	Finishes			
		HAB	HGA	HSI	HTI

 CM1741

H=9/16" (14.5mm), W=1-3/8" (35mm)

• • • •

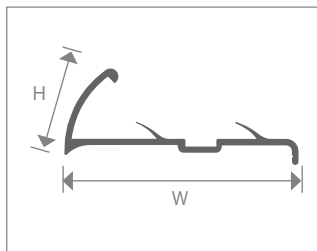

CM1750

Heavy duty pinned Tapdown for use with high pile action backed carpet up to 60oz. Ultra Pin system for maximum holding strength.

ADA compliant after install.*

LENGTH: 12 FT | PACK SIZE: 42 PCS

Profile Number	Dimensions	Finishes				
		CVG	HAB	HGA	HSI	HTI

 CM1750

H=5/8" (16mm), W=1-1/2" (38mm)

• • • • •

*  Denotes ADA Compliant Profiles

TAPDOWNS

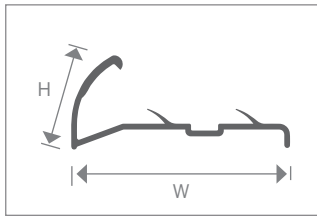
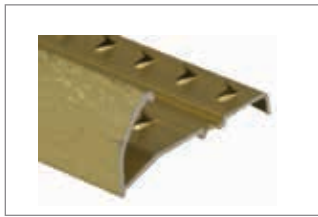

CM1760

Extra heavy duty pinned Tapdown for use with the thickest action backed carpets. Ultra Pin system for maximum holding strength. 3/4" (19mm) top face.

LENGTH: 12 FT | PACK SIZE: 42 PCS
AVAILABLE IN FLEX (CONTOUR) : 12 PCS 

Profile Number	Dimensions	Finishes			
		CVG	HGA	HSI	HTI
CM1760	H=3/4" (19mm), W=1-5/8" (41mm)	•	•	•	•

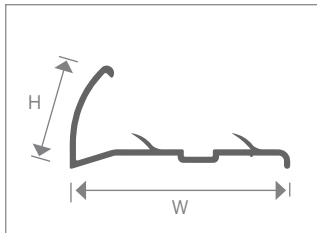

CM1770

Economy large lip 3/4" (19mm) Tapdown for use with the thickest action backed carpet. May be used in areas of low traffic. Ultra Pin system as our other pinned metals for maximum holding strength.

LENGTH: 12 FT | PACK SIZE: 42 PCS
AVAILABLE IN FLEX (CONTOUR) : 12 PCS 

Profile Number	Dimensions	Finishes				
		CVG	HAB	HGA	HSI	HTI
CM1770	H=3/4" (19mm), W=1-1/2" (38mm)	•	•	•	•	•

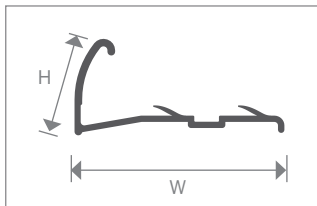

CM1780

Heavy duty pinned Tapdown used to hold down a very thick stretch of carpet.

ADA compliant after install.*

LENGTH: 12 FT | PACK SIZE: 42 PCS

Profile Number	Dimensions	Finishes		
		HGA	HSI	HTI
 CM1780	H=51/64" (20mm), W=1-11/16" (43mm)	•	•	•

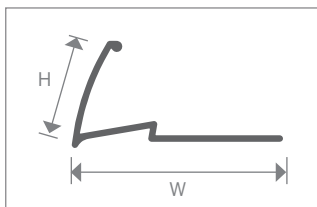
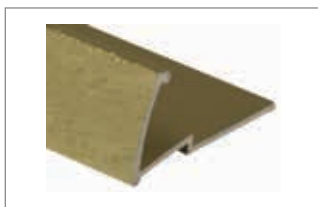

CM1621

Multi-purpose Tapdown that can be used for carpet underpad installation or glue down installations. The large lip covers even the thickest carpets with room for tucking the edge. Tackless can be used on the bottom for carpet with underpad installations.

LENGTH: 12 FT | PACK SIZE: 42 PCS

Profile Number	Dimensions	Finishes			
		HAB	HGA	HSI	HTI
CM1621	H=3/4" (19mm), W=1-3/8" (35mm)	•	•	•	•

*  Denotes ADA Compliant Profiles

TAPDOWNS

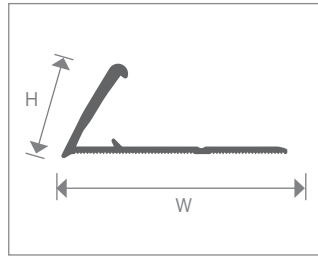
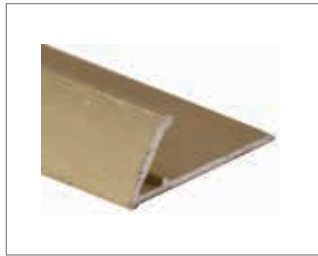

CM1650

Heavy duty pinless Tapdown for use with rubber backed and direct glue down installations. Nail holes on 12" (30.5cm) centres.

ADA compliant after install.*

LENGTH: 12 FT | PACK SIZE: 42 PCS

Profile Number	Dimensions	Finishes			
		HGA	HSI	HTI	KHG
ADA CM1650	H=5/8" (16mm), W=1-3/8" (35mm)	•	•	•	•

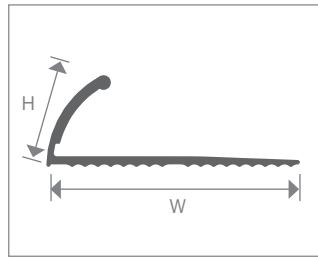
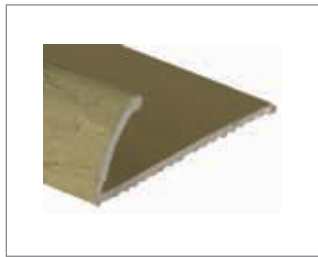

CM1653

Residential weight Pinless Tapdown for use with foam backed carpet or direct glue down installations.

ADA compliant after install.*

LENGTH: 12 FT | PACK SIZE: 42 PCS
AVAILABLE IN FLEX (CONTOUR) : 12 PCS

Profile Number	Dimensions	Finishes					
		CVG	HAB	HCA	HGA	HSI	HTI
ADA CM1653	H=1/2" (12.5mm) , W=1-1/4" (32mm)	•	•	•	•	•	•

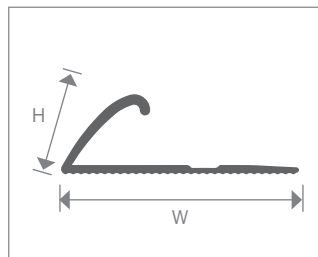

CM1657

Commercial duty Pinless Tapdown for use in high traffic commercial settings. Used in glue down carpet installations.

LENGTH: 12 FT | PACK SIZE: 12 PCS

Profile Number	Dimensions	Finishes
		HSI
CM1657	H=3/4" (19mm), W=1-7/8" (47.5mm)	•

* Denotes ADA Compliant Profiles

BEVEL BARS

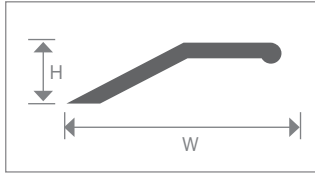
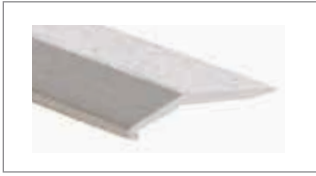

CM1196

1" (25mm) Residential Bevel Bar for transitions.
Made for height differentials of up to 5/16" (8mm).

LENGTH: 12 FT | PACK SIZE: 42 PCS

Profile Number	Dimensions	Finishes				
		CVG	HAB	HGA	HSI	HTI

ADA CM1196

H=1/4" (6.5mm), W=1" (25mm)

.

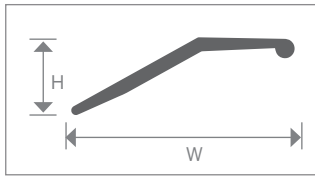

CM1197

1" (25mm) Economy Bevel Bar for transitions.
Made for height differentials of up to 5/16" (8mm).

LENGTH: 12 FT | PACK SIZE: 42 PCS

Profile Number	Dimensions	Finishes				
		CVG	HAB	HGA	HSI	HTI

ADA CM1197

H=1/4" (6.5mm), W=1" (25mm)

.

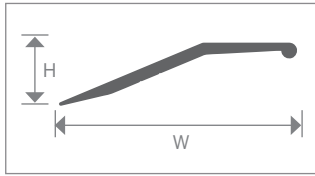
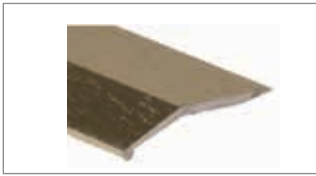

CM2196

1-1/2" (38mm) Residential Bevel Bar for transitions.
Made for height differentials of up to 3/8" (10mm).

LENGTH: 12 FT | PACK SIZE: 42 PCS
METAL DECOR*: 12 PCS

Profile Number	Dimensions	Finishes							
		CVG	DOK*	GOK*	HAB	HDB	HGA	HSI	HTI

ADA CM2196

H=3/8" (10mm), W=1-1/2" (38mm)

.

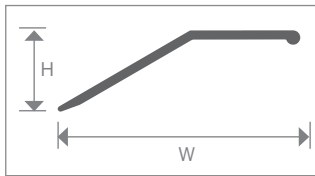

CM2197

1-1/2" (38mm) Economy Bevel Bar for transitions.
Made for height differentials of up to 3/8" (10mm).

LENGTH: 12 FT | PACK SIZE: 42 PCS

Profile Number	Dimensions	Finishes				
		CVG	HAB	HGA	HSI	HTI

ADA CM2197

H=3/8" (10mm), W=1-1/2" (38mm)

.

* ADA Denotes ADA Compliant Profiles

BEVEL BARS

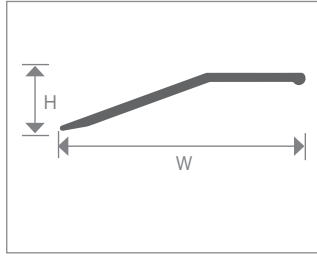

CM3196

2" (51mm) Commercial weight Bevel Bar. For use in high traffic areas or where extreme height differentials exists.

LENGTH: 12 FT | PACK SIZE: 12 PCS

Profile Number	Dimensions	Finishes		
		HGA	HSI	HTI
ADA CM3196	H=3/8" (10mm), W=2" (51mm)	•	•	•

SEAM BINDERS

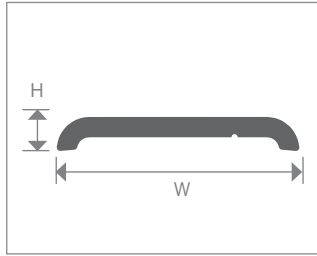
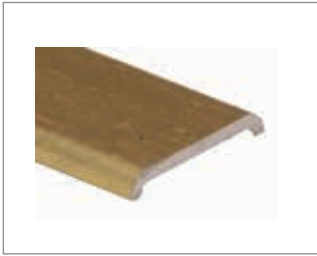

CM1342

3/4" (19mm) Seam Binder Covers seams of hard surface or resilient floors.

LENGTH: 12 FT | PACK SIZE: 42 PCS

Profile Number	Dimensions	Finishes		
		HGA	HSI	HTI
ADA CM1342	H=1/10" (2.5mm), W=3/4" (19mm)	•	•	•

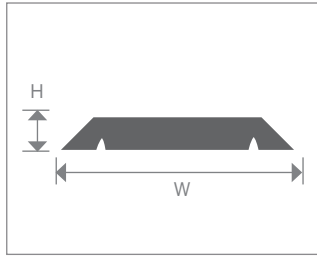
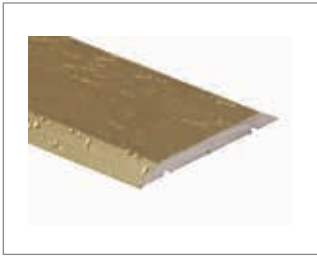

CM1344

1" (25mm) Flat Joiner. For binding seams at doorways where dissimilar floors of equal height meet.

LENGTH: 12 FT | PACK SIZE: 42 PCS

Profile Number	Dimensions	Finishes			
		CVG	HGA	HSI	HTI
ADA CM1344	H=1/10" (2.5mm), W=1" (25mm)	•	•	•	•

* ADA Denotes ADA Compliant Profiles

SEAM BINDERS

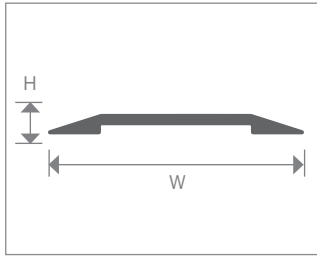
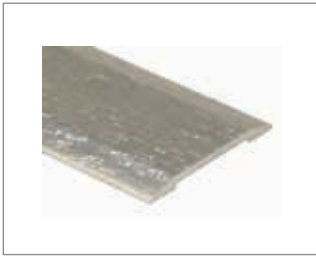

CM1142

1-1/4" (32mm) for seams where greater bridging is required.

LENGTH: 12 FT | PACK SIZE: 42 PCS
METAL DECOR*: 12 PCS

Profile Number	Dimensions	Finishes					
		CVG	GOK*	HAB	HGA	HSI	HTI
 CM1142	H=1/10" (2.5mm), W=1-1/4" (32mm)

NOSING

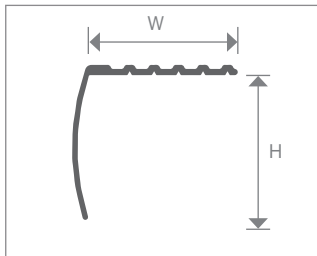
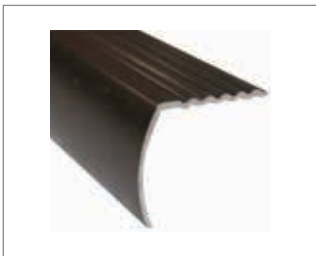

CM2184

1-1/8" (28.5mm) Drop Stair Nosing. Protects edge of stair from damage. This product is designed for light commercial or residential use.

LENGTH: 12 FT | PACK SIZE: 42 PCS
METAL DECOR*: 12 PCS

Profile Number	Dimensions	Finishes							
		CVG	DOK*	GOK*	HAB	HGA	HSI	HTI	KHG
CM2184	H=1-1/8" (28.5mm), W=1-1/8" (28.5mm)

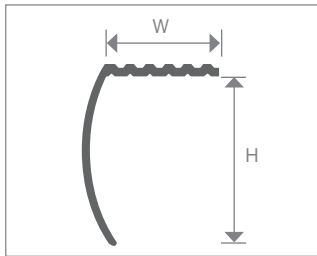
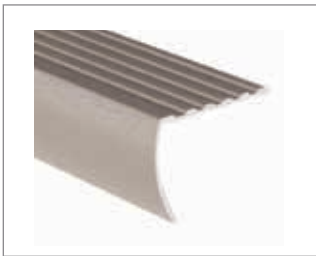

CM2190

1-3/8" (35mm) Drop Stair Nosing. Protects edge of stair from damage. This product is designed for light commercial or residential use.

LENGTH: 12 FT | PACK SIZE: 12 PCS

Profile Number	Dimensions	Finishes			
		HDB	HGA	HSI	HTI
CM2190	H=1-3/8" (35mm), W=1-1/8" (28.5mm)

*  Denotes ADA Compliant Profiles

NOSING

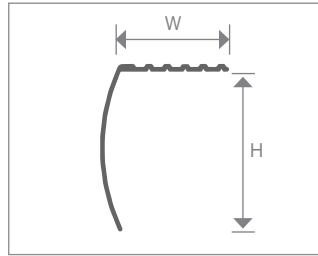

CM2191

1-5/8" (41mm) Drop Stair Nosing. Protects edge of stair from damage. This product is designed for light commercial or residential use.

LENGTH: 12 FT | PACK SIZE: 12 PCS

Profile Numbers	Dimensions	Finishes							
		CVG	HAB	HBK	HCR	HGA	HSI	HTI	KHG
CM2191	H=1-5/8" (41mm), W=1-1/8" (28.5mm)	•	•	•	•	•	•	•	•

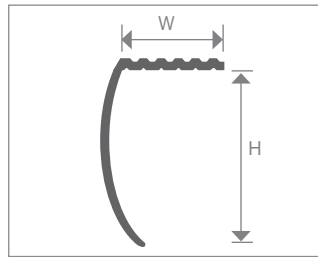

CM2193

1-7/8" (47.5mm) Drop Stair Nosing. Protects edge of stair from damage. This product is designed for light commercial or residential use.

LENGTH: 12 FT | PACK SIZE: 12 PCS

Profile Number	Dimensions	Finishes			
		HDB	HGA	HSI	HTI
CM2193	H=1-7/8" (47.5mm), W=1-3/16" (30mm)	•	•	•	•

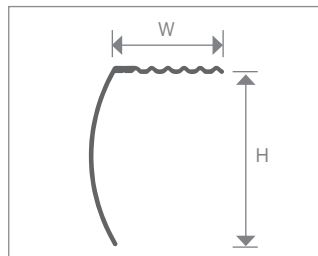

CM2199

Full 2" (51mm) Drop Stair Nosing. Protects edge of stair from damage. This product is designed for light commercial or residential use.

LENGTH: 12 FT | PACK SIZE: 12 PCS

Profile Numbers	Dimensions	Finishes		
		HGA	HSI	HTI
CM2199	H=2" (51mm), W=1-1/4" (32mm)	•	•	•

* Denotes ADA Compliant Profiles

NOSING

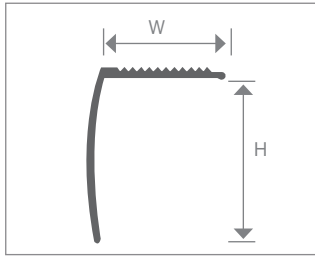
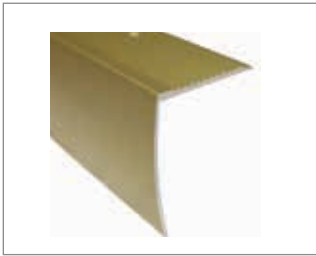

CM2194

Full 2" (51mm) Drop Stair Nosing with 1-1/2" (38mm) top tread. Covers most imperfections. The wider top tread allows for nosing to be secured away from stair edge especially when edges of stairs are damaged. Designed for commercial and residential use.

LENGTH: 12 FT | PACK SIZE: 12 PCS

Profile Number	Dimensions	Finishes		
		HGA	HSI	HTI
CM2194	H=2" (51mm), W= 1-1/2" (38mm)	•	•	•

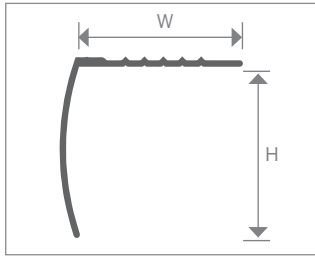

CM2182

1-1/8" (28.5mm) Drop Stair Nosing. Protects edge of stair from damage. Designed for light commercial or residential use.

LENGTH: 12 FT | PACK SIZE: 12 PCS

Profile Number	Dimensions	Finishes				
		CVG	HAB	HGA	HSI	HTI
CM2182	H=1-1/8" (28.5mm), W=1-1/8" (28.5mm)	•	•	•	•	•

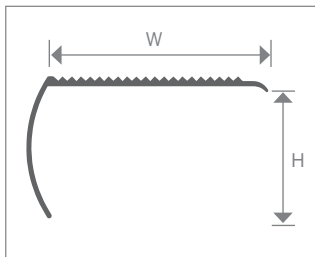

CM2195

1-1/2" (38mm) Drop X 2-1/2" (63.5mm) Tread Stair Nosing. Provides excellent traction and protection at edge of stair. Ideal for repairing stairs where existing nosing has worn out. Designed for commercial use. Available in Drilled Staggered (DS) or Drilled Center (DC).

LENGTH: 12 FT | PACK SIZE: 12 PCS

Profile Number	Dimensions	Finishes				
		BCL	HGA	HSI	HTI	SGA
CM2195	H=1-1/2" (38mm), W= 2-1/2" (63.5mm)	•	•	•	•	•

* Denotes ADA Compliant Profiles

NOSING

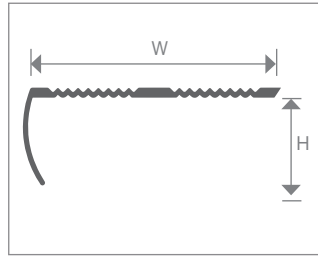
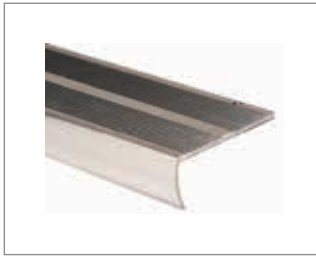

CM2198

1-3/16" (30mm) Drop X 3-1/16" (78mm) Tread Stair Nosing. Provides excellent traction and protection at edge of stair. Ideal for repairing stairs where existing nosing has worn out. Designed for commercial use.

Available in **Drilled Staggered (DS)** or **Drilled Center (DC)**.

LENGTH: 12 FT | PACK SIZE: 12 PCS

Profile Number	Dimensions	Finishes	
		BCL	SGA
CM2198	H=1-3/16" (30mm), W=3-1/16" (78mm)	•	•

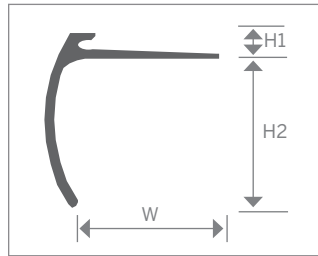

CM2185

Scribe to Nosing for 1/8" (3mm) VCT or resilient floors of similar thicknesses. 1-5/8" (41mm) inside drop to work in most settings. With adhesive reservoir for clean and easy installation.

LENGTH: 12 FT | PACK SIZE: 12 PCS

Profile Number	Dimensions	Finishes	
		SCA	STI
CM2185	H1=1/8" (3mm), H2=1-5/8" (41mm), W=1-3/16" (30mm)	•	•

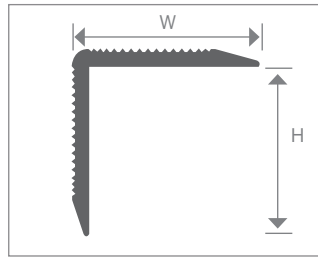

CM2192

1-3/8" (35mm) Drop Commercial Square Nose for use on concrete pan or square stair. Can also be used as a heavy duty corner guard. Drilling available by special order.

LENGTH: 12 FT | PACK SIZE: 12 PCS

Profile Number	Dimensions	Finishes
		MIL
CM2192	H=1-3/8" (35mm), W=1-1/2" (38mm)	•

*  Denotes ADA Compliant Profiles

THRESHOLDS

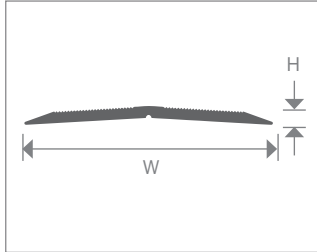

CM1144

Ribbed threshold for use in joining large gaps. Can also be used as an expansion joint cover. Suitable where low profile or wheelchair access is required. Available in **Drilled Staggered (DS)** or **Drilled Center (DC)**.

LENGTH: 12 FT | PACK SIZE: 12 PCS

Profile Number	Dimensions	Finishes
		MIL

 CM1144

H=3/16" (5mm), W=2-1/2" (63.5mm)

•

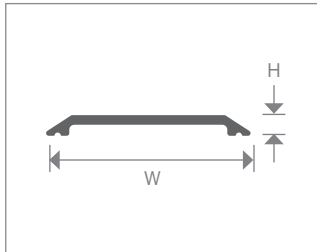
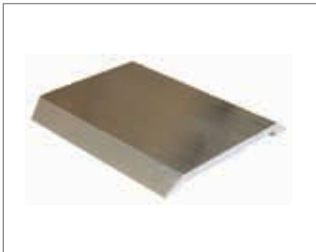

CM1145

Smooth-top threshold for use in joining large gaps. Can also be used as an expansion joint cover. Suitable for high traffic areas. Available in **Drilled Staggered (DS)** or **Drilled Center (DC)**.

LENGTH: 12 FT | PACK SIZE: 12 PCS

Profile Number	Dimensions	Finishes
		MIL

 CM1145

H=1/4" (6.5mm), W=2-1/2" (63.5mm)

•

*  Denotes ADA Compliant Profiles

THRESHOLDS

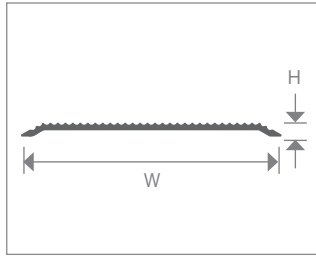

CM1146/1148

Ribbed threshold for use in joining large gaps. Can also be used as an expansion joint cover.

Available in **Drilled Staggered (DS)** or **Drilled Center (DC)**.

LENGTH: 12 FT | PACK SIZE: 12 PCS

Profile Number	Dimensions	Finishes
		MIL

CM1146

H=1/8" (3mm), W=2-1/2" (63.5mm)

•

CM1148

H=1/8" (3mm), W=4" (101.5mm)

•

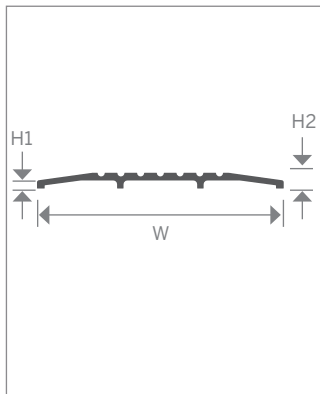

WSB4424/4425/4426

Barrier Free quality extruded Aluminum Thresholds designed for use in commercial applications. Support bars built for added strength.

Full 1/2" (12.5mm) height for retrofit situations. 1/4" (6.5mm) low profile (LP) height.

Construction Materials Board (CMB) listed material.

- Thresholds come drilled center line, staggered, or undrilled.
- **Thresholds shown meet requirements of ADA, CAN/CSA-B651 and ADMG-1992.**

Available in **Drilled Staggered (DS)** or **Drilled Center (DC)**.

LENGTH: 12 FT | PACK SIZE: 5 PCS

Profile Number	Dimensions	Finishes
		MIL

WSB4424

H1=1/8" (3mm), H2=1/2" (12.5mm), W=4" (10cm)

•

WSB4425

H1=1/8" (3mm), H2=1/2" (12.5mm), W=5" (13cm)

•

WSB4426

H1=1/8" (3mm), H2=1/2" (12.5mm), W=6" (15cm)

•

WSB4424LP

H1=1/8" (3mm), H2=1/4" (6.5mm), W=4" (10cm)

•

WSB4425LP

H1=1/8" (3mm), H2=1/4" (6.5mm), W=5" (13cm)

•

WSB4426LP

H1=1/8" (3mm), H2=1/4" (6.5mm), W=6" (15cm)

•

* Denotes ADA Compliant Profiles

SPECIALTY

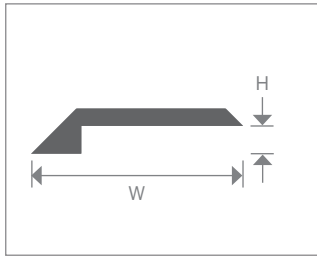
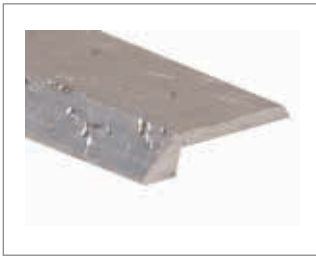

CM1121

Tile Edge Cap for Finishing the edge of tile or resilient floor. Accommodates materials from 0.080" (2mm) up to 1/8" (3mm) thick.

LENGTH: 12 FT | PACK SIZE: 42 PCS

Profile Number	Dimensions	Finishes	
		HSI	HTI

CM1121

H=1/10" (2.5mm), W=3/4" (19mm)

•

•

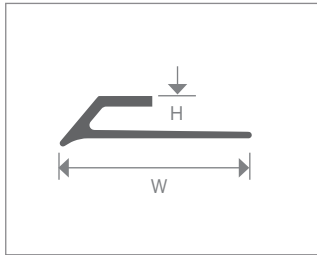

CM1122

Resilient Flooring Cap. Used when coving sheet goods up the wall to finish off the exposed edge. For materials up to 1/10" (2.5mm) or 1/8" (3mm) thick.

LENGTH: 12 FT | PACK SIZE: 12 PCS

Profile Number	Dimensions	Finishes
		SCA

CM1122

H=1/10" (2.5mm), W=15/16" (24mm)

•

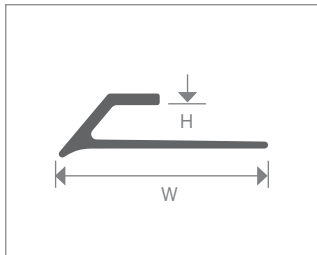
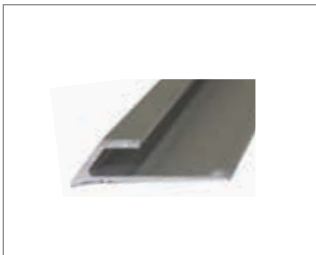

CM1125

Resilient Flooring Cap. Used when coving sheet goods up the wall to finish off the exposed edge. For materials up to 1/10" (2.5mm) or 1/8" (3mm) thick.

LENGTH: 12 FT | PACK SIZE: 12 PCS

Profile Number	Dimensions	Finishes
		SCA

CM1125

H=1/8" (3mm), W=15/16" (24mm)

•

* Denotes ADA Compliant Profiles

SPECIALTY

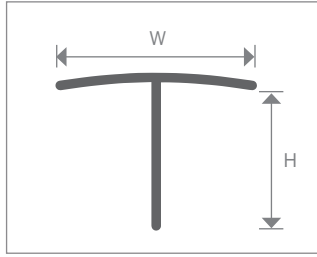

CM1155

7/8" (22mm) wide Hatch Cover molding. Used to cover gaps in the floor where hatch covers are installed.

LENGTH: 12 FT | PACK SIZE: 12 PCS

Profile Number	Dimensions	Finishes		
		MIL	SCA	STI
ADA CM1155	H=5/8" (16mm), W=7/8" (22mm)	•	•	•

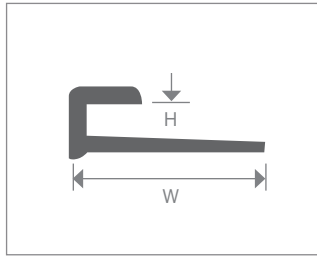
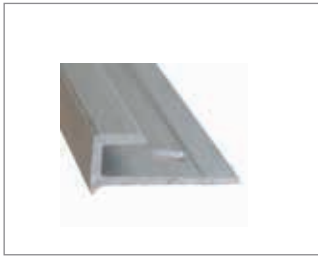

CM14281

1/4" (6mm) face cap trim for 1/8" (3mm) material.

LENGTH: 12 FT | PACK SIZE: 42 PCS

Profile Number	Dimensions	Finishes		
		MIL	SCA	STI
ADA CM14281	H=1/8" (3mm), W=3/4" (19mm)	•	•	•

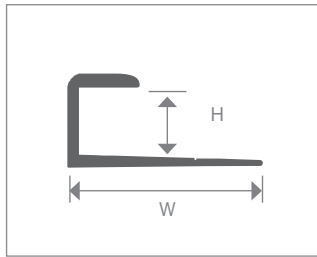

CM2130

9/32" (7mm) face cap trim for 1/4" (6.5mm) material.

LENGTH: 12 FT | PACK SIZE: 12 PCS

Profile Number	Dimensions	Finishes	
		SCA	SGA
CM2130	H=1/4" (6.5mm), W=3/4" (19mm)	•	•

* ADA Denotes ADA Compliant Profiles

SPECIALTY

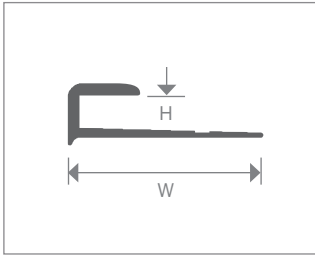
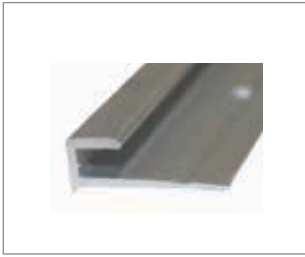

CM330

Small face cap trim for 1/10" (2.5mm) material.

LENGTH: 12 FT | PACK SIZE: 12 PCS

Profile Number	Dimensions	Finishes	
		MIL	SCA

CM330

H=1/10" (2.5mm), W=13/16" (20.5mm)

•

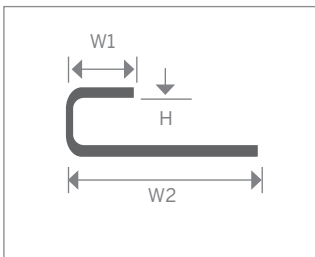

CM331

Stainless Steel Cove Cap for use on the wall to provide a coved finish. Can be sealed with silicone to offer excellent resistance to dirt build up. Accepts materials up to 1/8" (3mm) thick.

LENGTH: 8 FT | PACK SIZE: 12 PCS

Profile Number	Dimensions	Finishes	
		MIL	SCA

CM331

H=1/8" (3mm), W1=5/16" (8mm), W2=7/8" (22mm)

•

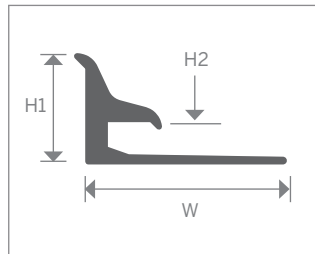
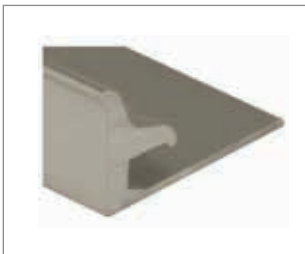

CM3330

1/10" (2.5 mm) insert cove for resilient sheet goods up to 1/10" (2.5 mm).

LENGTH: 12 FT | PACK SIZE: 40 PCS

Profile Number	Dimensions	Finishes	
		MIL	SCA

CM3330

H1=7/16" (11mm), H2=1/10" (2.5mm), W=3/4" (19mm)

•

•

* Denotes ADA Compliant Profiles

SPECIALTY

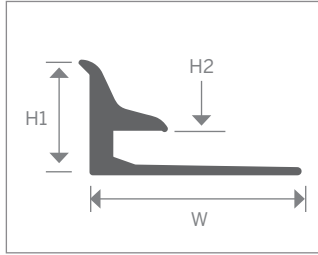
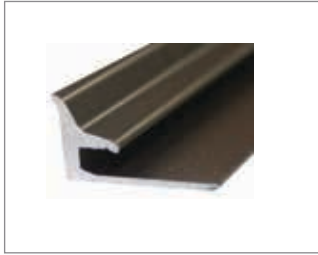

CM3340

1/8" (3mm) insert cove for resilient sheet goods up to 1/8" (3mm).

LENGTH: 12 FT | PACK SIZE: 12 PCS

Profile Number	Dimensions	Finishes	
		MIL	SCA
CM3340	H1=7/16" (11mm), H2=1/8" (3mm), W=3/4" (19mm)	•	•

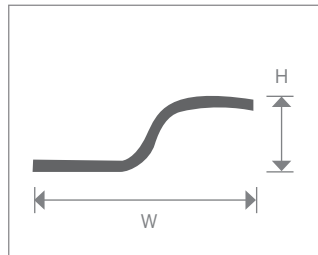
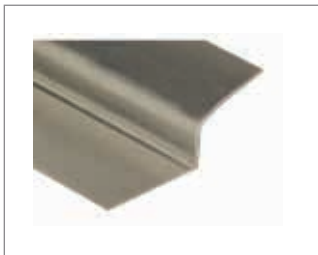

CM3220

Z-Bar is an offset hearth metal for installing carpet around fireplaces. Provides grip while remaining invisible.

LENGTH: 4 FT | PACK SIZE: 25 PCS

Profile Number	Dimensions	Finishes
		MIL
CM3220	H=1/2" (12.5mm), W=1-3/16" (30mm)	•

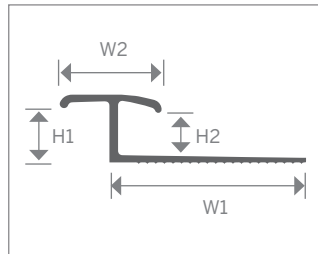

CM1666

Pinless Divider for commercial use. Used where glue down carpet meets ceramic, hardwood, laminate, cushion floor on plywood or sheet vinyl on subfloor. (Can be adjusted to accept slightly thinner materials). For high traffic areas.

LENGTH: 12 FT | PACK SIZE: 42 PCS

Profile Number	Dimensions	Finishes	
		HSI	HTI
 CM1666	H1=7/16" (11mm), H2=5/16" (8mm), W1=1-7/16" (36.5mm), W2=3/4" (19mm)	•	•

*  Denotes ADA Compliant Profiles

SPECIALTY

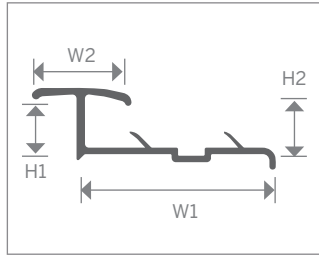

CM1766

Pinned Divider for commercial use. Used where stretched in carpet meets ceramic, hardwood, laminate, cushion floor on plywood or sheet vinyl on subfloor. (Can be adjusted to accept slightly thinner materials). For high traffic areas.

LENGTH: 12 FT | PACK SIZE: 12 PCS

Profile Number	Dimensions	Finishes	
		HGA	HSI

ADA CM1766	H1=7/16" (11mm), H2=5/16" (8mm), W1= 1-13/16" (46mm), W2= 1-1/2" (38mm)	•	•
-------------------	---	---	---

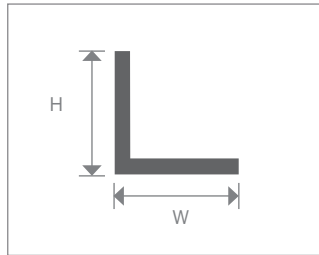

CM1162/1163/1164

Angle for use on corners to protect edge. Can also be used as an accent. Can be drilled.

LENGTH: 12 FT | PACK SIZE: 25 PCS

Profile Numbers	Dimensions	Finishes		
		BCL	SCA	STI

CM1162	H=1/2" (12.5mm), W=1/2" (12.5mm)	•	•	•
CM1163	H=3/4" (19mm), W=3/4" (19mm)	•	•	•
CM1164	H=1" (25mm), W=1" (25mm)	•	•	•

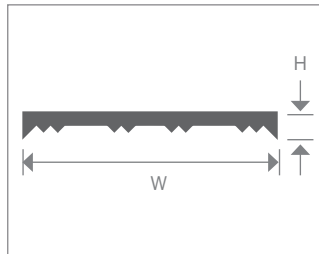

CM3210

2-1/4" (57mm) wide **SABRE TOOTH STRAIGHT EDGE**. Grooves prevent tool from moving by biting into carpet. Allows carpet technician to cut carpet up to 12 feet wide. Clear Anodized to prevent marking carpet.

SIZE AVAILABLE: SE 29" SE 36" SE 75" SE 84" SE 150"
PACK SIZE: 1 PC

Profile Number	Dimensions	Finishes
		SCA

CM3210	H=1/4" (6.5mm), W=2-1/4" (57mm)	•
--------	---------------------------------	---

* **ADA** Denotes ADA Compliant Profiles

CAP TRACK - PINLESS

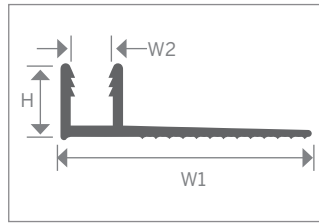
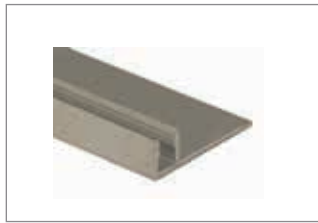

CM1651/1655

Pinless Channel for use where rubber backed carpet meets dissimilar flooring.

LENGTH: 12 FT | PACK SIZE: 25 PCS
 AVAILABLE IN FLEX (CONTOUR) : 12 PCS 
 ALSO AVAILABLE WITH PRE-PUNCHED BASE

Profile Numbers	Dimensions	Style		Finishes
		NARROW	WIDE	MIL
		Use with all 1/8" (3mm) Leg "E" or "T" caps	Use with all 3/16" (5mm) Leg "E" or "T" caps	
CM1651	H=3/8" (10mm), W1=1-1/4" (32mm), W2=1/8" (2.5mm)	•		•
CM1655	H=3/8" (10mm), W1=1-1/4" (32mm), W2=5/32" (4mm)		•	•

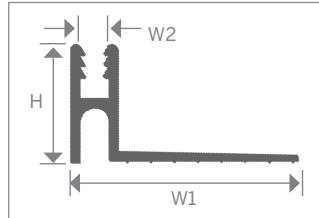

CM1658/1659/1660

Pinless Channel for areas where extra strength or height is needed. Extra height for installations where floor covering are over 3/8" (9.5mm) high but less than 5/8" (16mm). Tack strips can be used when installing under pad.

LENGTH: 12 FT | PACK SIZE: 12 PCS

Profile Numbers	Dimensions	Style		Finishes
		NARROW	WIDE	MIL
		Use with all 1/8" (3mm) Leg "E" or "T" caps	Use with all 3/16" (5mm) Leg "E" or "T" caps	
CM1658	H=1/2" (12.5mm), W1=1-1/4" (32mm), W2=1/8" (3mm)	•		•
CM1659	H=5/8" (16mm), W1=1-1/4" (32mm), W2=1/8" (3mm)	•		•
CM1660	H=11/16" (17.5mm), W1=1-1/4" (32mm), W2=3/16" (4mm)		•	•

CAP TRACK - PINNED

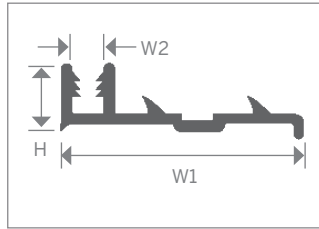

CM1751/1752/1755

Pinned Channel for use where action backed carpet meets dissimilar flooring. Ultra Pin continuous pinning system for maximum holding strength.

LENGTH: 12 FT | PACK SIZE: 25 PCS
 AVAILABLE IN FLEX (CONTOUR): 12 PCS

Profile Numbers	Dimensions	Style		Finishes
		NARROW	WIDE	MIL
		Use with all 1/8" (3mm) Leg "E" or "T" caps	Use with all 3/16" (5mm) Leg "E" or "T" caps	
CM1751	H=3/8" (10mm), W1=1-7/16" (36.5mm), W2=1/8" (3mm)	•		•
CM1752	H=3/8" (10mm), W1=1-1/2" (38mm), W2=1/8" (3mm)	•		•
CM1755	H=3/8" (10mm), W1=1-7/16" (36.5mm), W2=3/16" (5mm)		•	•

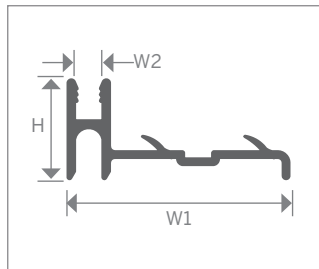

CM1759

Wide Pinned Channel for areas where extra strength or height is needed. Added strength of one piece aluminum track holds up under increased traffic. Ultra Pin continuous pinning system for maximum holding strength. Extra height for installations where floor covering are over 3/8" (10mm) high but less than 3/4" (19mm).

LENGTH: 12 FT | PACK SIZE: 12 PCS

Profile Number	Dimensions	Style - WIDE	Finishes
		Use with all 3/16" (5mm) Leg "E" or "T" caps	MIL
CM1759	H=11/16" (17.5mm), W1=1-1/2" (38mm), W2=5/32" (4mm)	•	•

LUXURY VINYL FINISHING ESSENTIALS

The **M-D PRO** line of luxury vinyl transitions and finishing accessories provide versatility and function for the most common LVT/LVP applications. Providing these **ESSENTIAL profiles** allows you to consolidate inventory while satisfying customer needs.

- All Floor and Stair profiles can accommodate flooring material up to **7mm thick!**
- **New sizes** provide versatility and range for flooring material thickness
- **Universal 3/8"** top lip accepts both floating and glue down applications
- **Rounded corner edge** for smooth and **safe transition**
- **Durable, anodized finishes** complement today's most popular flooring styles
- Reduce SKU count and stock these **ESSENTIALS** today!

LVT FLOOR PROFILES

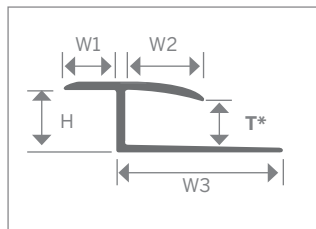

LVT TO CARPET

LVT to Carpet transition for use where Luxury Vinyl Tile or Plank Flooring meets low pile carpet or other flooring material.

LENGTH: 12 FT | PACK SIZE: 12 PCS

*(T) APPLICATION THICKNESS

Profile Number	Dimensions	Finishes		
		SCA	SAB	STI
LV8903	T=5/64" - 1/8" (2mm - 3mm), H=1/4" (6.5mm), W1=1/4" (6.5mm), W2=3/8" (10mm), W3=3/4" (19mm)	•	•	•
LV8905	T=5/32" - 13/64" (4mm - 5mm), H=1/4" (6.5mm), W1=1/4" (6.5mm), W2=3/8" (10mm), W3=3/4" (19mm)	•	•	•
LV8907	T=15/64" - 9/32" (6mm - 7mm), H=1/4" (6.5mm), W1=1/4" (6.5mm), W2=3/8" (10mm), W3=3/4" (19mm)	•	•	•

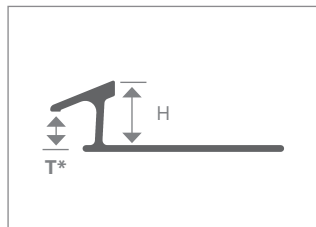

LVT TO TILE ADAPTER

LVT to Tile Adapter for use where tile meets existing Luxury Vinyl Tile or Plank Flooring up to 1/4" (6.5mm) thick.

LENGTH: 8 FT | PACK SIZE: 12 PCS

*(T) APPLICATION THICKNESS

Profile Number	Dimensions	Finishes									
		BBR	BCL	MIL	SAB	SBK	SCA	SCP	SDB	SGA	STI
CM2161	T=1/4" (6.5mm), H=3/8" (10mm)	•	•	•	•	•	•	•	•	•	•
CM2162	T=1/4" (6.5mm), H=1/2" (12.5mm)	•	•	•	•	•	•	•	•	•	•

LVT FLOOR PROFILES

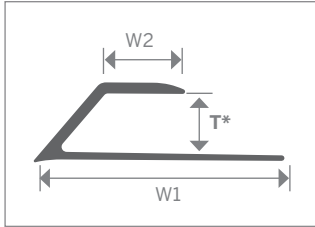
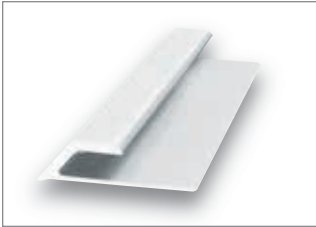

REDUCER

Reducer for use with Luxury Vinyl Tile or Plank Flooring.

LENGTH: 12 FT | PACK SIZE: 12 PCS

*(T) APPLICATION THICKNESS

Profile Numbers	Dimensions	Finishes		
		SAB	SCA	STI
ADA LV8303	T=5/64" - 1/8" (2mm - 3mm), W1=1" (25mm), W2=3/8" (10mm)	•	•	•
ADA LV8305	T=5/32" - 13/64" (4mm - 5mm), W1=1" (25mm), W2=3/8" (10mm)	•	•	•
ADA LV8307	T=15/64" - 9/32" (6mm - 7mm), W1=1" (25mm), W2=3/8" (10mm)	•	•	•

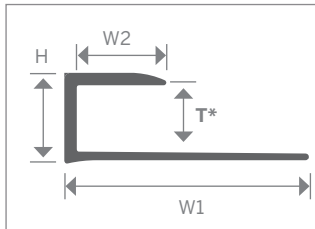
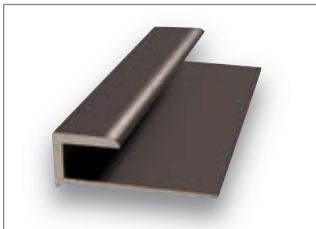

J-MOLDING

J-Molding/End Cap for use with Luxury Vinyl Tile or Plank Flooring.

LENGTH: 12 FT | PACK SIZE: 12 PCS

*(T) APPLICATION THICKNESS

Profile Numbers	Dimensions	Finishes		
		SAB	SCA	STI
ADA LV8503	T=5/64" - 1/8" (2mm - 3mm), H=15/64" (6mm), W1=1" (25mm), W2=3/8" (10mm)	•	•	•
ADA LV8505	T=5/32" - 13/64" (4mm - 5mm), H=19/64" (7.5mm), W1=1" (25mm), W2=3/8" (10mm)	•	•	•
ADA LV8507	T=15/64" - 9/32" (6mm - 7mm), H=3/8" (10mm), W1=1" (25mm), W2=3/8" (10mm)	•	•	•

* ADA Denotes ADA Compliant Profiles

LVT STAIR PROFILES

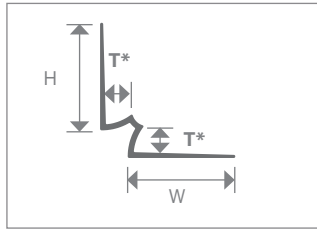

INSIDE COVE

Inside Cove for use with Luxury Vinyl Tile or Plank Flooring. Typically used to finish corners of stair tread-to-riser applications. Avoid dirt build-up in riser corners.

LENGTH: 12 FT | PACK SIZE: 12 PCS

*(T) APPLICATION THICKNESS

Profile Numbers	Dimensions	Finishes		
		SAB	SCA	STI
LV8603	T=5/64" - 1/8" (2mm - 3mm), H/W=1" (25mm)	•	•	•
LV8605	T=5/32" - 13/64" (4mm - 5mm), H/W=1" (25mm)	•	•	•
LV8607	T=15/64" - 9/32" (6mm - 7mm), H/W=1" (25mm)	•	•	•

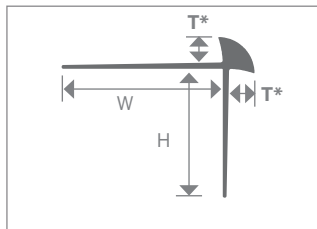

OUTSIDE CORNER SQUARE STAIR NOSE

Outside Corner Square Stair Nosing for use with Luxury Vinyl Tile or Plank Flooring. Minimal reveal outside corner edge provides clean finish.

LENGTH: 12 FT | PACK SIZE: 12 PCS

*(T) APPLICATION THICKNESS

Profile Numbers	Dimensions	Finishes		
		SAB	SCA	STI
LV8803	T=5/64" - 1/8" (2mm - 3mm), H=1" (25mm), W=1-1/4" (32mm)	•	•	•
LV8805	T=5/32" - 13/64" (4mm - 5mm), H=1" (25mm), W=1-1/4" (32mm)	•	•	•
LV8807	T=15/64" - 9/32" (6mm - 7mm), H=1" (25mm), W=1-1/4" (32mm)	•	•	•

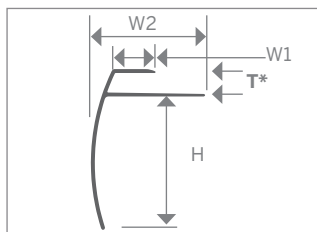

STAIR NOSING

Stair Nosing for use with Luxury Vinyl Tile or Plank Flooring.

LENGTH: 12 FT | PACK SIZE: 12 PCS

*(T) APPLICATION THICKNESS

Profile Numbers	Dimensions	Finishes		
		SAB	SCA	STI
LV8703	T=5/64" - 1/8" (2mm - 3mm), H=1-7/8" (47.5mm), W1=3/8" (10mm), W2=1-5/8" (41mm)	•	•	•
LV8705	T=5/32" - 13/64" (4mm - 5mm), H=1-7/8" (47.5mm), W1=3/8" (10mm), W2=1-5/8" (41mm)	•	•	•
LV8707	T=15/64" - 9/32" (6mm - 7mm), H=1-7/8" (47.5mm), W1=3/8" (10mm), W2=1-5/8" (41mm)	•	•	•

* Denotes ADA Compliant Profiles

LVT MULTI-PURPOSE PROFILES

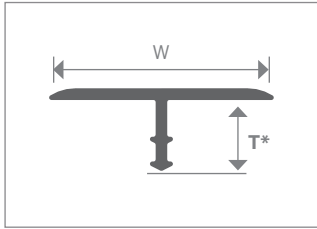

T-MOLDING

T-Molding for use between Luxury Vinyl Tile/Plank Flooring and other flooring materials of equal heights where expansion is expected.

LENGTH: 8 FT | PACK SIZE: 12 PCS

*(T) APPLICATION THICKNESS

Profile Number	Dimensions	Finishes								
		BBR	BCL	MIL	SBK	SCA	SCP	SDB	SGA	STI
ADA CM1156	T=5/16" (8mm), W=7/8" (22mm)

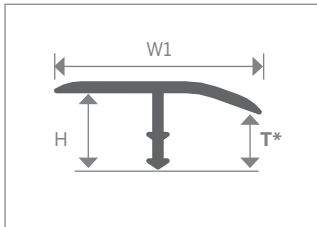

T-MOLDING REDUCER

T-Molding Reducer for use between Luxury Vinyl Tile/Plank Flooring and other flooring materials of different heights where expansions is expected.

LENGTH: 8 FT | PACK SIZE: 12 PCS

*(T) APPLICATION THICKNESS

Profile Numbers	Dimensions	Finishes	
		SCA	STI
ADA CM1158	T=13/64" - 9/32" (5mm - 7mm), H=5/16" - 3/8" (8mm - 10mm), W=7/8" (22mm)	.	.

M-D MULTI-FLOOR®

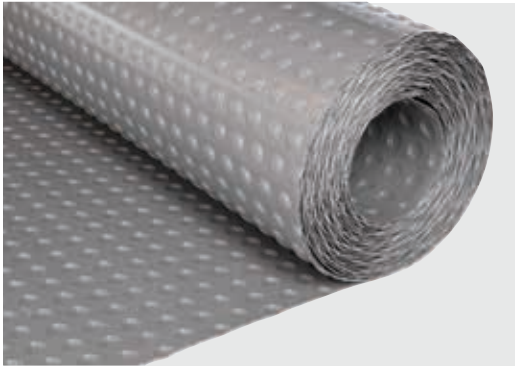

MULTI-FLOOR®

The M-D MULTI-FLOOR® underlayment system provides advanced durability & protection for ALL floating floor applications! The versatile underlayment is suitable for multiple areas of application and substrates. Exclusive elastic spring technology allows for dynamic contraction, delivering a durable and comfortable walking surface for years to come. With the ability to be used under all floating floor surface materials (hardwood, laminate, LVT/LVP, and carpet), M-D MULTI-FLOOR® is the ultimate solution for the most common flooring applications!

PACK SIZE: 1 ROLL

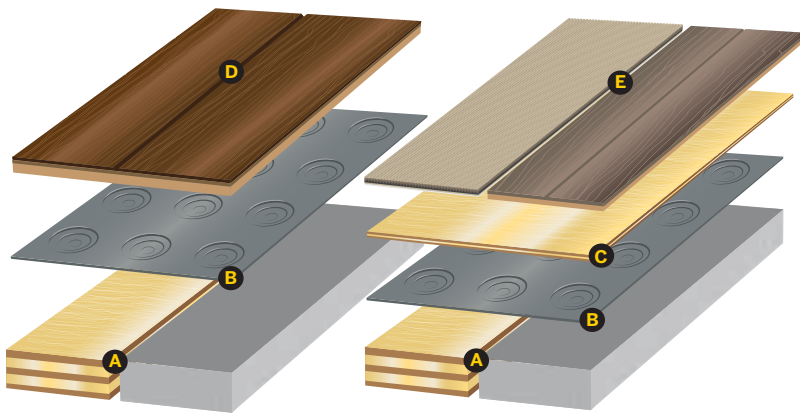

- A. Concrete or plywood substrate
- B.  MULTI-FLOOR®
- C. 5/8" (16 mm) tongue-and-groove plywood
- D. Hardwood or laminate
- E. LVT/LVP or carpet

Profile Number	Dimensions	Color
----------------	------------	-------

MD8010GRY20

215 sq.ft (20 m) roll

Grey



M-D MULTI-FLOOR® SEALING TAPE

Tape designed to seal all joints between sections of M-D MULTI-FLOOR® underlayment. The tape resists moisture and provides premium bonding capabilities.*

PACK SIZE: 6 ROLLS

Profile Number	Dimensions	Color
----------------	------------	-------

MD8020BLK55

180.4' x 1.9" (55 m x 48 mm)

Black



* Seal all joints with **M-D MULTI-FLOOR® SEALING TAPE**

NOTE: This step is recommended for all applications, but it is required for installations done below grade or on concrete substrates that are above or below grade.

ALUMINUM FINISHES

(Finishes may not appear exactly as shown. Please request a sample prior to placing an order)

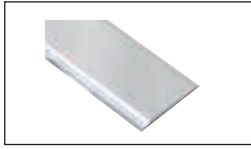

BCL
BRIGHT CLEAR



CVG
COVENTRY GOLD



DOK*
METAL DECOR DARK OAK



GOK*
METAL DECOR GOLDEN OAK

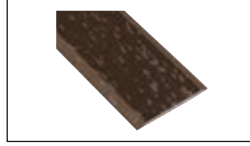

HAB
HAMMERED ANTIQUE BRONZE



HCR
HAMMERED COPPER

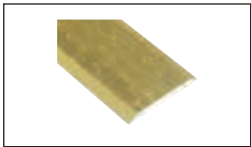

HGA
HAMMERED GOLD ANODIZED



HSI
HAMMERED SILVER

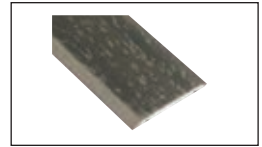

HTI
HAMMERED TITANIUM



KHG
KINTRIM HAMMERD GOLD

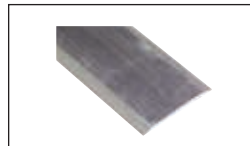

MIL
MILL FINISH



SAB
SATIN ANTIQUE BRONZE

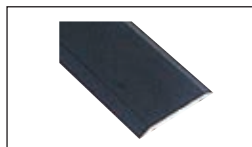

SBK
SATIN BLACK

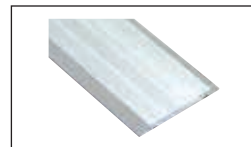

SCA
SATIN CLEAR ANODIZED



STI
SATIN TITANIUM

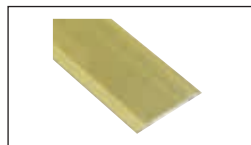

SGA
SATIN GOLD ANODIZED

****DISCLAIMER:** DO NOT USE MILL FINISH IN WET AREAS. MILL product is aluminum in its raw state, therefore there is a high risk of oxidization on the product and staining on the flooring material and/or grout when it is used in wet areas.

BROKEN CARTON POLICY

Less than full cartons may be purchased on select items with a minimum up charge of 20%, please contact your Customer Service Representatives for details. No returns will be granted for items that fall below the standard carton/pack size.

M-D PRO LIMITED WARRANTY

M-D Pro products are warranted for a period of 1 (one) year from date of shipment. All products will be subject to the following manufacture warranties; Products will conform to original product and contract description with only such reasonable variations as is acceptable in the trade. These products will be fit for the purposes for which they were intended and that they will be professionally packaged and labeled. M-D PRO will replace any defective product found if said defect is identified before installation. If a defect is found after installation, M-D PRO must be notified in writing within 10 days of installation. The customer must then, at M-D PRO's discretion, allow an inspection of the installation. If upon inspection, M-D PRO determines the product to be defective, M-D Pro will at its own discretion supply replacement materials that conform to the contract requirements or issue a credit equal to but not exceeding the original purchase price for the goods in question. M-D PRO assumes no liability or responsibilities for labor or the cost of other materials used in such installations.

These warranties do not circumvent any individual product category warranties implied or stated by M-D PRO.

Warranties do not apply to the following specified items, terms and conditions:

- A.** Exact matching of color, shade, texturing or mottling.
- B.** Any warranties, other than expressed above, implied or promised by any sales representative.
- C.** Tears, scratches, burns, or other damage caused by improper installation, improper use or maintenance.
- D.** Sales of "Seconds", or "Imperfect" goods.
- E.** Problem caused by moisture, hydrostatic pressure or alkali in the sub-floor.
- F.** Problem caused by installation with non-approved adhesive. If you are unsure about the suitability of a particular adhesive, please call us for our recommendations.
- G.** Product installed outdoors. M-D PRO products are designed for interior use only.
- H.** Color degradation caused by sunlight or other U.V. exposure. These warranties are supplied in lieu of any other warranty, expressed or implied. All product specifications are subject to change without notice.

NOTES

NOTES



5720 Ambler Drive
Mississauga, ON, L4W 2B1
Telephone: 1 800 565 6653
E-mail: service@mdteam.com
Website: www.mdpro.com

Part #: MPCATMDPRO
Print date: July 2022