



# LAMINATE, MDF & WOOD FLOORING ACCESSORIES

Product Catalog **2022**





The information in this catalog is gathered from customers, end users, and our personal experiences. The products have been created to provide you with solutions for today's transition challenges.

We would like to thank you for your patronage and for giving us the opportunity to become "Your Flooring Accessories Specialist". Being "Your Flooring Accessories Specialist" means ...

- We will provide the best service in the industry by utilizing a team of dedicated Customer Service Specialists.
- Our product will maintain a high degree of consistency and quality to meet the needs of our customers, by manufacturing our product to ISO standards.
- We will incorporate our customers input when making decisions, by using ideas and suggestions brought to us.
- All our business dealings will be handled with integrity, by ensuring customers and suppliers alike know the facts.
- New product innovation will be an integral part of our business strategy, by continually anticipating market trends and designing the accessories demanded by the industry.

For questions or concerns pertaining to products contained in this catalog, please contact our Customer Service department. Our team of specialists will be happy to assist you.

**Toll free:** 1 800 565 6653

**E-mail:** [service@mdteam.com](mailto:service@mdteam.com)

**Website:** [www.mdpro.com](http://www.mdpro.com)

# TABLE OF CONTENTS

## WOOD GRAIN METAL LAMINATE MOLDINGS

### EXPANSION JOINT (DIVIDER)

LM4002 .....Pg.04

### REDUCERS

LM4003 .....Pg.04

LM4005 .....Pg.04

### STAIR NOSING

LM4004 .....Pg.04

### TRACKS

LM3001 .....Pg.05

LM3002 .....Pg.05

LM3003 .....Pg.05

LM3004 .....Pg.05

## METAL LAMINATE MOLDINGS

### END STOPS

LM1001 .....Pg.06

LM1251 .....Pg.06

### EXPANSION JOINTS (DIVIDERS)

LM1002 .....Pg.06

LM1005 .....Pg.07

LM1255 .....Pg.07

### REDUCERS

LM1003 .....Pg.07

LM1253 .....Pg.07

### STAIR NOSING

LM1004 .....Pg.08

LM1254 .....Pg.08

## MDF LAMINATE MOLDINGS

### T-MOLDINGS

LM7002 .....Pg.10

LM7102 .....Pg.10

## MDF LAMINATE MOLDINGS

### REDUCERS

LM7003 .....Pg.10

LM7103 .....Pg.10

## STAIR NOSING

LM7004 .....Pg.11

LM7104 .....Pg.11

## QUARTER ROUND

LM7010 .....Pg.11

## MDF LAMINATE ACCESSORIES

### SHIM

LM7030 .....Pg.12

## MDF LAMINATE FINISHES GUIDE

.....Pg.13

## UNFINISHED OAK

### EQUALIZERS

FW6830 .....Pg.15

FW6840 .....Pg.15

### OVERLAP EDGING

FW6820 .....Pg.15

### REDUCERS

FW6800 .....Pg.16

FW3810 .....Pg.16

FW6880 .....Pg.16

### SEAM BINDERS

FW6860 .....Pg.17

FW6870 .....Pg.17

### T-MOLDING

FW6890 .....Pg.17

## UNFINISHED OAK & MAPLE

### EQUALIZER

FW6901 .....Pg.18

### REDUCERS

FW6900 .....Pg.18

FW6904 .....Pg.18

FW6905 .....Pg.18

### SEAM BINDER

FW6902 .....Pg.19

## STAIR NOSING

FW6906 .....Pg.19

## T-MOLDING

FW6903 .....Pg.19

## PRIMED PINE

### COLONIAL BASE

FW5010 .....Pg.20

FW5020 .....Pg.20

### QUARTER ROUND

FW5210 .....Pg.20

### ECONOMY BASE SHOE

FW5220 .....Pg.21

### PREMIUM BASE SHOE/DOOR STOP

FW5110 .....Pg.21

## M-D MULTI-FLOOR

MD8010GRY20 .....Pg.22

## MARKETING TOOLS

### CHAIN SETS

MPCHAINSET11 .....Pg.24

MPCHAINSET12 .....Pg.24

MPCHAINSETS13 .....Pg.24

MPCHAINSETS15 .....Pg.24

MPCHAINSET27 .....Pg.24

MPCHAINSET32 .....Pg.25

MPSWATCH614MDF .....Pg.25

### SAMPLE BOARD

MPSAMPLEMDF .....Pg.25

## POLICY AND WARRANTY

.....Pg.26

# METAL LAMINATE FLOORING TRIMS

**LAMINATE** flooring products have become the economical alternative to hardwood. Our wide variety of aluminum profiles and wood grain finishes provide the ideal solution for any installation or transitional needs. Our wood grain laminate moldings are made of solid aluminum providing incomparable strength and durability. In addition the wood grain surface is treated with an aluminum oxide finish that increases surface hardness up to 3 times more over other sealers and coatings.



# WOOD GRAIN METAL LAMINATE MOLDINGS

## EXPANSION JOINT (DIVIDER)

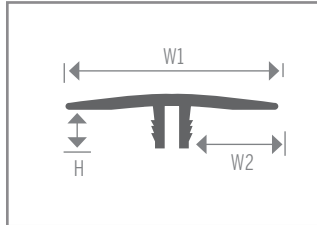

Expansion Joint (Divider) for floating floors. Used when installing large areas of floating floors as an expansion joint. Overhang allows expansion of floors and eliminates buckling. Should be used for any installation greater than 12' in any one direction.

**LENGTH: 12 FT | PACK SIZE: 12 PCS**

Profile Number	Dimensions	Finishes (see page 5 for wood grain finishes)				
		MAP	OAK	ROK	WAL	SCA
LM4002	W1=1-7/16" (3.7cm), W2=5/8" (16mm), H=5/16" (8mm)	.	.	.	.	.

## REDUCERS

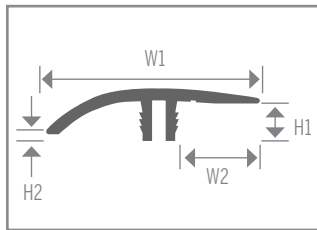

Floating Floor Reducer. Reduces from 5/16" to 1/8" floor. Used when butting floating floors on top of existing floors, subfloor, floor tile or resilient sheet goods.

**LENGTH: 12 FT | PACK SIZE: 12 PCS**

Profile Number	Dimensions	Finishes (see page 5 for wood grain finishes)				
		MAP	OAK	ROK	WAL	SCA
LM4003	W1=1-1/2" (3.8cm), W2=11/16" (17.5mm), H1=5/16" (8mm), H2=1/8" (3mm)	.	.	.	.	.
LM4005	W1=1-5/8" (4.1cm), W2=5/8" (16mm), H1=5/16" (8mm), H2=0"	.	.	.	.	.

## STAIR NOSING

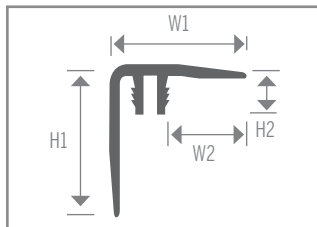

Stair Nosing finishes edge of stair. For nosing applications use LM3002, LM3003 or LM3004 track.

**LENGTH: 12 FT | PACK SIZE: 12 PCS**

Profile Number	Dimensions	Finishes (see page 5 for wood grain finishes)				
		MAP	OAK	ROK	WAL	SCA
LM4004	W1=1-5/16" (3.3cm), W2=5/8" (16mm), H1=1-3/16" (3cm), H2=1/4" (6mm)	.	.	.	.	.

\* All dimensions are approximate

# WOOD GRAIN METAL LAMINATE FINISHES

Wood Grain Metal Laminate Moldings available in: Oak (OAK), Red Oak (ROK), Maple (MAP), Walnut (WAL)



## TRACKS

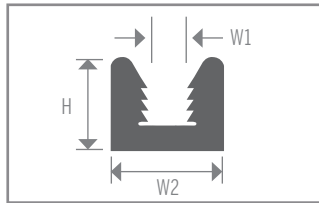
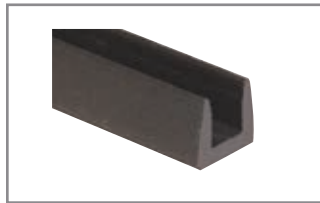

The easy to install LM3001 snap-in track design. Made of rigid PVC.

**LENGTH: 12 FT | PACK SIZE: 50 PCS**

Profile Number	Dimensions	Finishes	
		GRY	WHT
LM3001	W1=7/32"(6mm), W2=7/16"(11mm), H=5/16"(8mm)	•	

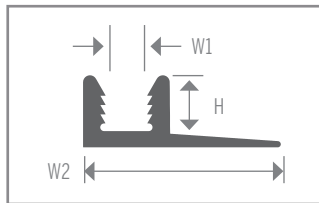
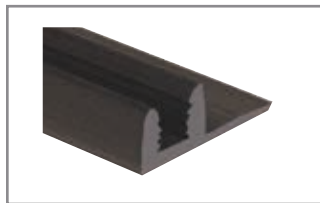

Track to be used for laminate floors. Flange adds strength and stability. Staggered drilled. Made of rigid PVC.

**LENGTH: 12 FT | PACK SIZE: 25 PCS**

Profile Number	Dimensions	Finishes	
		GRY	WHT
LM3002	W1=7/32"(6mm), W2=1"(2.5cm), H=5/16"(8mm)	•	

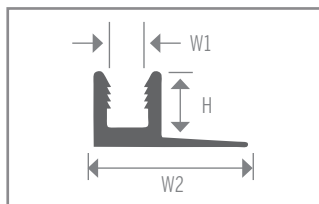

Track to be used for laminate floors. Track provides secure grip of molding for greater durability and safety. Flange adds extra strength and stability. Made of rigid PVC.

**LENGTH: 12 FT | PACK SIZE: 25 PCS**

Profile Number	Dimensions	Finishes	
		GRY	WHT
LM3003	W1=7/32"(6mm), W2=1"(2.5cm), H=3/8"(10mm)	•	
LM3004	W1=7/32"(6mm), W2=1"(2.5cm), H=1/2"(12.5mm)		•

# METAL LAMINATE MOLDINGS

## END STOPS

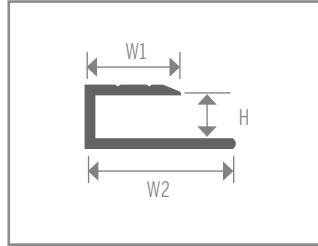
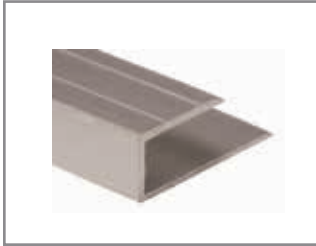

One piece floating floor End Stop (J-Mold) used when butting floating floors to walls, patio doors or other flooring materials of similar heights such as hardwood or ceramic tile.

**LENGTH: 8 FT | PACK SIZE: 12 PCS**

Profile Number	Dimensions	Finishes		
		SCA	STI	SCP
LM1001	W1=3/4"(2cm), W2=1-3/16"(3cm), H=5/16"(8mm)	•	•	•
LM1251	W1=9/16"(14mm), W2=1-3/16"(3cm), H=1/2"(12.5mm)	•	•	•

## EXPANSION JOINT (DIVIDER)

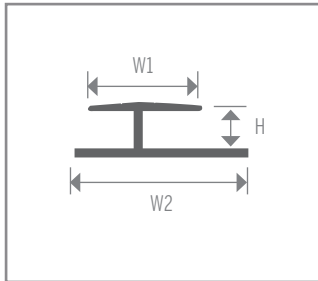

One piece Expansion Joint (divider) for floating floors. Used when installing large areas of floating floors as an expansion joint. Large overhangs allows expansion of floors and eliminates buckling. Should be used for any installation greater than 12' in any one direction.

**LENGTH: 8 FT | PACK SIZE: 12 PCS**

Profile Number	Dimensions	Finishes		
		SCA	STI	SCP
LM1002	W1=1"(2.5cm), W2=1-5/8"(4.1cm), H=5/16"(8mm)	•	•	•

\* All dimensions are approximate

# METAL LAMINATE MOLDINGS

## EXPANSION JOINTS (DIVIDER)

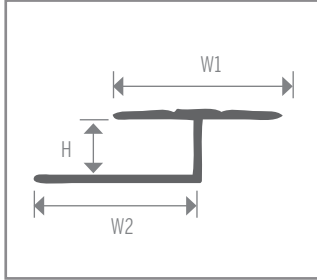
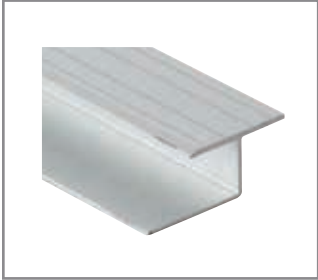

One piece Expansion Joint (divider) for floating floors. Used when installing large areas of floating floors as an expansion joint. Large overhangs allows expansion of floors and eliminates buckling. Should be used for any installation greater than 12' in any one direction.

**LENGTH: 8 FT | PACK SIZE: 12 PCS**

Profile Number	Dimensions	Finishes		
		SCA	STI	SCP
LM1005	W1=1"(2.5cm), W2=1"(2.5cm), H=5/16"(8mm)	•	•	•
LM1255	W1=1-1/10"(2.8cm), W2=1-1/16"(2.7cm), H=1/2"(12.5mm)	•	•	•

## REDUCERS

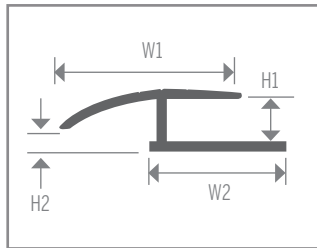

One piece floating floor Reducer. Used when butting floating floors up to 1/8" tile or resilient sheet goods. The large overhang allows the laminate floor to expand and contract up to 1/2".

**LENGTH: 8 FT | PACK SIZE: 12 PCS**

Profile Number	Dimensions	Finishes		
		SCA	STI	SCP
LM1003	W1=1-1/2"(12.5mm), W2=1-1/10"(2.8cm), H1=5/16"(8mm), H2=1/8"(3mm)	•	•	•
LM1253	W1=1-9/16"(40mm), W2=1-1/10"(2.8cm), H1=1/2"(12.5mm), H2=1/8"(3mm)	•	•	•



# METAL LAMINATE MOLDINGS

## STAIR NOSINGS

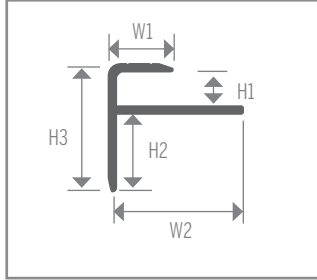

One piece floating floor Stair Nosing. Used when installing floating floors on stairs. Can also be used with ceramic tiles or other floors of similar thickness.

**LENGTH: 8 FT | PACK SIZE: 12 PCS**

Profile Number	Dimensions	Finishes		
		SCA	STI	SCP
LM1004	W1=5/8"(16mm), W2=1-3/16"(3cm), H1=5/16"(8mm), H2=1-5/8"(4.1cm), H3=2"(5.1cm)	•	•	•
LM1254	W1=9/16"(14mm), W2=1-3/16"(3cm), H1=1/2"(13mm), H2=1-5/8"(4.1cm), H3=2-1/4"(5.7cm)	•	•	•

## ALUMINUM FINISHES

(Finishes may not appear exactly as shown. Please request a sample prior to placing an order)

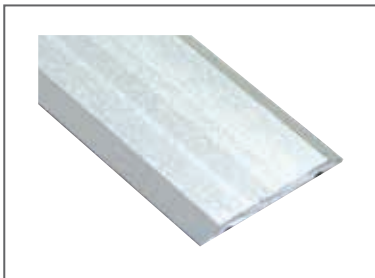

**SCA**  
SATIN  
CLEAR  
ANODIZED



**STI**  
SATIN  
TITANIUM



**SCP**  
SATIN  
CHAMPAGNE

\* All dimensions are approximate

# MDF LAMINATE MOLDINGS

Our superior **MDF LAMINATE MOLDINGS** are built on structurally sound, water resistant **MDF (MEDIUM DENSITY FIBERBOARD)**. The finish is wrapped laminate using waterproof adhesive. The laminate surface is impregnated with aluminum oxide then wrapped over the transition to give our transitions superior durability over the competition. Choose from a selection of 32 colours and wood grain styles to complement today's most popular flooring finishes.



# MDF LAMINATE MOLDINGS

## T-MOLDINGS

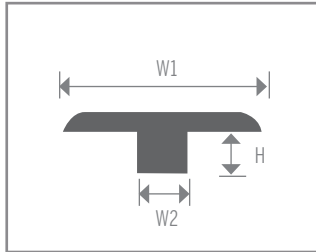

Finishes gap between level flooring areas.

**LENGTH: 6 FT | PACK SIZE: 7 PCS**  
**\*SEE PAGES 13 FOR FINISHES**

Profile Number	Dimensions	To be used with	
		6-9 mm	10-14 mm
		laminate/floating floors	
LM7002	W1=1-3/4"(4.5cm), W2=1/2"(12.5cm), H=1/4"(6mm)	•	
LM7102	W1=1-3/4" (4.5cm), W2=1/2" (12.5cm), H=7/16"(11mm)		•

## REDUCERS

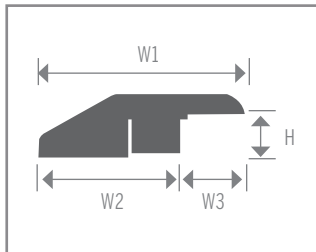
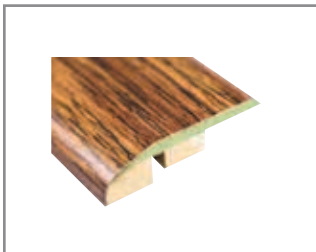

Finishes edge between laminate/wood flooring and other hard surface or carpet. Finishes edge at outside doors.

**LENGTH: 6 FT | PACK SIZE: 7 PCS**  
**\*SEE PAGES 13 FOR FINISHES**

Profile Number	Dimensions	To be used with	
		6-9 mm	10-14 mm
		laminate/floating floors	
LM7003	W1=1-3/4" (4.5cm), W2=1-1/8"(2.9cm), W3=5/8"(16mm), H=3/8"(9.5mm)	•	
LM7103	W1=1-3/4" (4.5cm), W2=1-1/8"(2.9cm), W3=5/8"(16mm), H=1/2"(12.5mm)		•

\* All dimensions are approximate

# MDF LAMINATE MOLDINGS

## STAIR NOSINGS

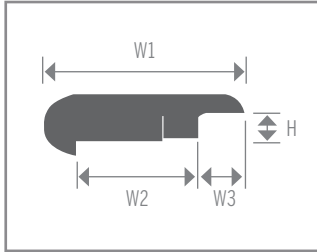

Finishes edge of laminate/wood flooring at stairs.

**LENGTH: 8 FT | PACK SIZE: 5 PCS**  
**\*SEE PAGES 13 FOR FINISHES**

Profile Number	Dimensions	To be used with	
		6-9 mm	10-14 mm
LM7004	W1=2-1/8" (5.4cm), W2=1-1/10" (2.8cm), W3=5/8" (16mm), H=1/4" (6mm)	•	
LM7104	W1=2-1/8" (5.4cm), W2=1-1/10" (2.8cm), W3=5/8" (16mm), H=1/2" (12.5mm)		•

## QUARTER ROUND

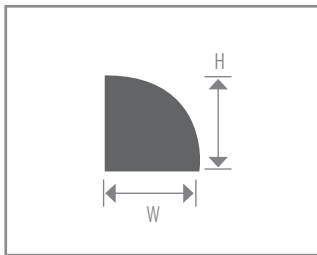
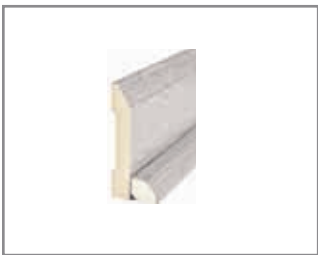

Quarter round finishes space between laminate/wood flooring and wall base.

**LENGTH: 8 FT | PACK SIZE: 10 PCS**  
**\*SEE PAGES 13 FOR FINISHES**

Profile Number	Dimensions	<span style="border: 1px solid black; border-radius: 50%; padding: 2px;">SO</span> Special Order Only
LM7010	W=3/4" (2cm), H=5/8" (16mm)	Minimum Order Quantity for Quarter Round: 50 Please allow a minimum of 15 business days for Special Orders

# MDF LAMINATE ACCESSORIES

## SHIM

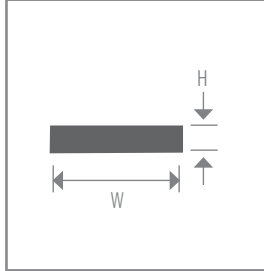

Shim - when used in conjunction with each other - can accommodate installation of the MDF moldings with floors up to 15 mm thick.

**LENGTH: 6 FT | PACK SIZE: 40 PCS**

Profile Number	Dimensions
LM7030	W=13.5mm, H=4mm

## METAL SNAP-IN TRACK

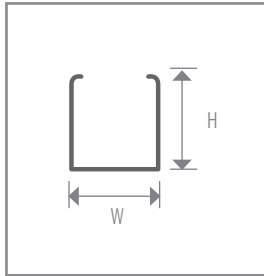

Metal Snap-In track is included with each molding and comes complete with screws and anchors. Not sold separately.

**LENGTH: 6 FT**



















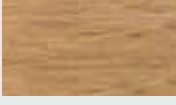





LM7003 with track

Dimensions
W=9/16"(14mm), H=5/16"(8mm)

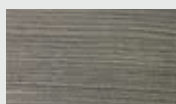
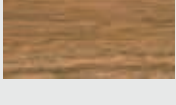

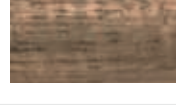
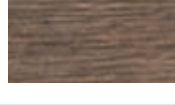
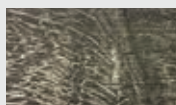
\* All dimensions are approximate

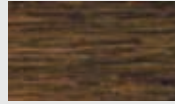
**MDF LAMINATE FINISHES GUIDE** All Colors Stocked in 6-9 MM and 10-14 MM

Color Number	Finishes	Color Number	Finishes	Color Number	Finishes
256		456		576	
258		248		448	
300		790		786	
532		476		533	
220		354		568	
224		640		520	
902		506		177	
672		638		521	
173		294		188	
492		626		169	
				648 (50 Quarter Round Only)	

**DISCLAIMER:** Wood grain finishes may not appear exactly as shown. Request a sample for actual color visual.

**50** Minimum Order Quantity for Quarter Round: 50. Please allow a minimum of 15 business days for Special Orders.

# PRIMED & UNFINISHED WOOD

Whether you are looking for a primed or unfinished product, we offer a versatile selection of wood moldings to meet your installation needs. Our pine moldings are ready-to-use and provide ease of finishing while our line of unfinished oak and maple moldings offer the flexibility to paint or varnish for custom applications. Available in several different profiles with pre-drilled and un-drilled options, our wood products are sure to please many installers and their clients.



# UNFINISHED OAK

## EQUALIZER

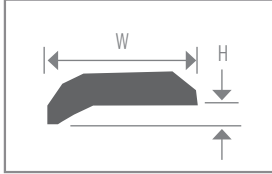

Equalizer. Joins adjacent floor height differentials. Items are supplied **pre-drilled** with a sanded but unfinished surface.

**LENGTH: 6 FT | PACK SIZE: 5 PCS**

Profile Number	Dimensions	Materials
		Solid Oak

FW6830

W=1-1/2"(3.8cm), H=3/16"(5mm)

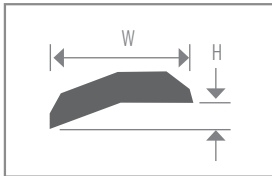

Equalizer. Joins adjacent floor height differentials. Items are supplied **pre-drilled** with a sanded but unfinished surface.

**LENGTH: 6 FT | PACK SIZE: 5 PCS**

Profile Number	Dimensions	Materials
		Solid Oak

FW6840

W=2"(5.1cm), H=1/4"(6mm)

## OVERLAP EDGING

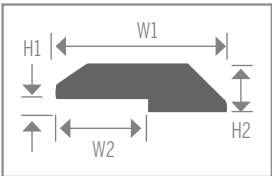

Overlap Edging. For use with resilient floors or tile up to 1/8". Items are supplied **pre-drilled** with a sanded but unfinished surface.

**LENGTH: 6 FT | PACK SIZE: 5 PCS**

Profile Number	Dimensions	Materials
		Solid Oak

FW6820

W1=13/16"(2.1cm), W2=7/16"(11mm), H1=1/8"(3mm), H2=3/8"(9.5mm)



# UNFINISHED OAK

## REDUCERS

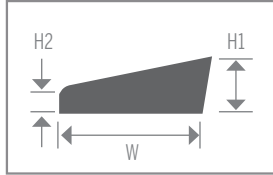

Reducer. Used when butting floating floors up to 1/8" tile or resilient sheet goods. Items supplied **undrilled**.

**LENGTH: 6 FT | PACK SIZE: 5 PCS**

Profile Number	Dimensions	Materials
		Solid Oak
FW6800	W=1"(2.5cm), H1=3/8"(9.5mm), H2=1/4"(6mm)	•

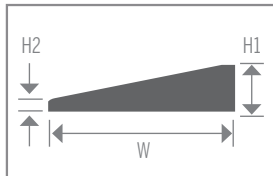

Reducer. Used when butting floating floors up to 1/8" tile or resilient sheet goods. Items supplied **undrilled**.

**LENGTH: 6 FT | PACK SIZE: 5 PCS**

Profile Number	Dimensions	Materials
		Solid Oak
FW3810	W=1-3/4"(4.5cm), H1=7/16"(11mm), H2=1/8"(3mm)	•

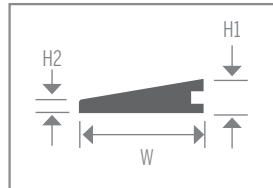

Reducer molding for reducing 3/4" flooring materials such as ceramic or hardwood. Gives smooth transition from lower to higher floors. Joins adjacent floor height differentials. Items supplied **undrilled**.

**LENGTH: 6 FT | PACK SIZE: 5 PCS**

Profile Number	Dimensions	Materials
		Solid Oak
FW6880	W=2-1/2"(6.4cm), H1=3/4"(2cm), H2=1/4"(6mm)	•

\* All dimensions are approximate

# UNFINISHED OAK

## SEAM BINDERS

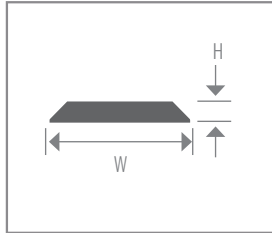

Seam binder for joining adjacent floors of equal height. Items are supplied **pre-drilled** with a sanded but unfinished surface.

**LENGTH: 6 FT | PACK SIZE: 5 PCS**

Profile Number	Dimensions	Materials
		Solid Oak
FW6860	W=1-3/4"(4.5cm), H=3/8"(9.5mm)	•
FW6870	W=2-1/2"(6.4cm), H=3/8"(9.5mm)	•

## T-MOLDING

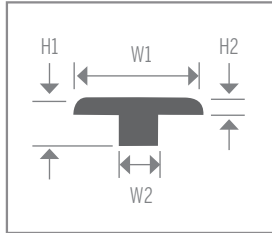

T-Molding. Joins adjacent floors of equal heights. Items supplied **undrilled**.

**LENGTH: 6 FT | PACK SIZE: 5 PCS**

Profile Number	Dimensions	Materials
		Solid Oak
FW6890	W1=1-1/2"(3.8cm), W2=7/16"(11mm), H1=9/16"(14mm), H2=3/16"(5mm)	•

# UNFINISHED OAK & MAPLE

## EQUALIZER

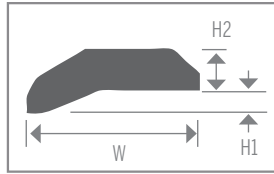

Equalizer. Joins adjacent floor height differentials up to 3/16".  
Items supplied **undrilled**.

**LENGTH: 6 FT | PACK SIZE: 5 PCS**

Profile Number	Dimensions	Materials	
		OAK	MAP
FW6901	W=1-1/2"(3.8cm), H1=3/16"(5mm), H2=5/16"(8mm)	•	•

## REDUCERS

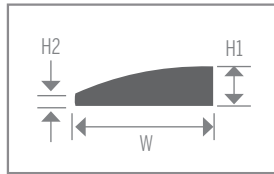

Reducer molding for reducing flooring materials such as ceramic or hardwood. Gives smooth transition from lower to higher floors.  
Items supplied **undrilled**.

**LENGTH: 6 FT | PACK SIZE: 5 PCS**

Profile Number	Dimensions	Materials	
		OAK	MAP
FW6900	W=1-3/4"(4.5cm), H1=7/16"(11mm), H2=1/8"(3mm)	•	•

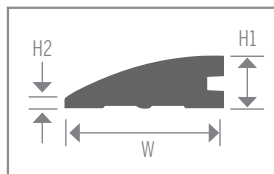

Reducer molding for reducing flooring materials such as ceramic or hardwood. Gives smooth transition from lower to higher floors.  
Items supplied **undrilled**.

**LENGTH: 6 FT | PACK SIZE: 5 PCS**

Profile Number	Dimensions	Materials	
		OAK	MAP
FW6904	W=2-1/2"(6.4cm), H1=3/4"(2cm), H2=1/8"(3mm)	•	•

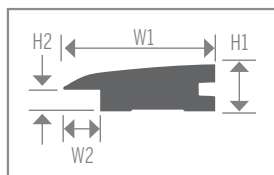

Reducer molding for reducing 3/4" hardwood to carpet.  
Items supplied **undrilled**.

**LENGTH: 6 FT | PACK SIZE: 5 PCS**

Profile Number	Dimensions	Materials	
		OAK	MAP
FW6905	W1=2-1/2"(6.4cm), W2=5/8"(16mm), H1=3/4"(2cm), H2=3/8"(9.5mm)	•	•

\* All dimensions are approximate

# UNFINISHED OAK & MAPLE

## SEAM BINDER

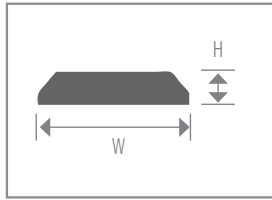

Seam binder for joining adjacent floors of equal height 1-3/4" wide. Items supplied **undrilled**.

**LENGTH: 6 FT | PACK SIZE: 5 PCS**

Profile Number	Dimensions	Materials	
		OAK	MAP
FW6902	W=1-3/4"(4.5cm), H=5/16"(8mm)	•	•

## STAIR NOSING

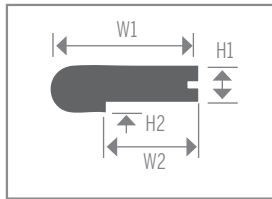

Finishes 3/4" hardwood at top of stairs or landings. Items supplied **undrilled**.

**LENGTH: 4 or 8 FT | PACK SIZE: 1 PCS**

Profile Number	Dimensions	Materials	
		OAK	MAP
FW6906	W1=3-1/2"(9cm), W2=2-1/4"(5.7cm), H1=3/4"(2cm), H2=1/4"(6mm)	•	•

## T-MOLDING

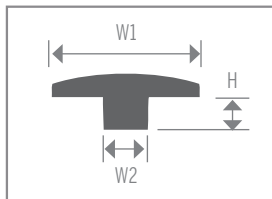

T-molding for joining adjacent floors of equal height 1-3/4" wide. Items supplied **undrilled**.

**LENGTH: 6 FT | PACK SIZE: 5 PCS**

Profile Number	Dimensions	Materials	
		OAK	MAP
FW6903	W1=1-3/4"(4.5cm), W2=1/2"(12.5mm), H=5/8"(16mm)	•	•

# PRIMED PINE

## COLONIAL BASE

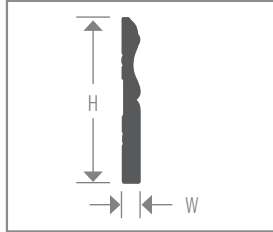

Colonial baseboard provides a traditional solution for most interior spaces. The classic curved design adds charm and finishing flare.

**LENGTH: 12 FT | PACK SIZE: 8 PCS**

Profile Number	Dimensions	Materials
		PNE (Pine)
FW5010	W=1/2"(12mm), H=4-1/4"(10.7cm)	•

## QUARTER ROUND

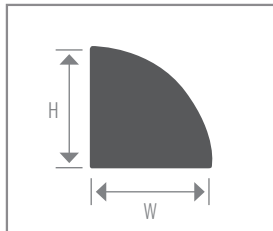

Quarter round, the universal baseboard finishing accessory! Use to hide any imperfections, gaps and height differences between laid flooring surfaces and the baseboard.

**LENGTH: 12 FT | PACK SIZE: 20 PCS**

Profile Number	Dimensions	Materials
		PNE (Pine)
FW5210	W=5/8"(1.58cm), H=5/8"(1.58cm)	•

\* All dimensions are approximate

# PRIMED PINE

## ECONOMY BASE SHOE

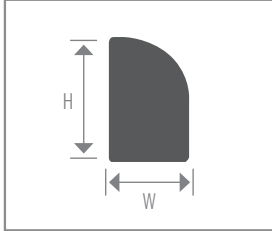

Economy Base Shoe can be used where less visibility and protrusion from the wall base is desired. Use to hide any imperfections, gaps and height differences between laid flooring surfaces and the baseboard.

**LENGTH: 12 FT | PACK SIZE: 20 PCS**

Profile Number	Dimensions	Materials
		PNE (Pine)
FW5220	W=7/16"(1.1cm), H=11/16"(1.74cm)	•

## PREMIUM BASE SHOE / DOOR STOP

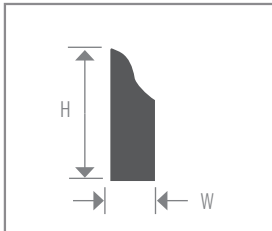

Premium base shoe/door stop is a great alternative to quarter round finishing. It adds a continuation of the colonial design to the base while also hiding any imperfections, gaps and height differences between laid flooring surfaces and the baseboard. This profile is often used as a door stop as well.

**LENGTH: 12 FT | PACK SIZE: 12 PCS**

Profile Number	Dimensions	Materials
		PNE (Pine)
FW5110	W=3/8"(9.5mm), H=1-1/8"(2.8cm)	•

# M-D MULTI-FLOOR®

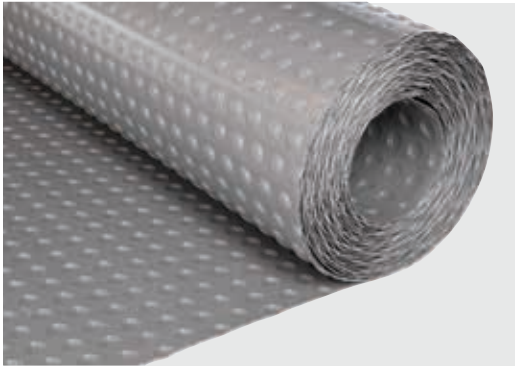

## MULTI-FLOOR®

The M-D MULTI-FLOOR® underlayment system provides advanced durability & protection for ALL floating floor applications! The versatile underlayment is suitable for multiple areas of application and substrates. Exclusive elastic spring technology allows for dynamic contraction, delivering a durable and comfortable walking surface for years to come. With the ability to be used under all floating floor surface materials (hardwood, laminate, LVT/LVP, and carpet), M-D MULTI-FLOOR® is the ultimate solution for the most common flooring applications!

**PACK SIZE: 1 ROLL**

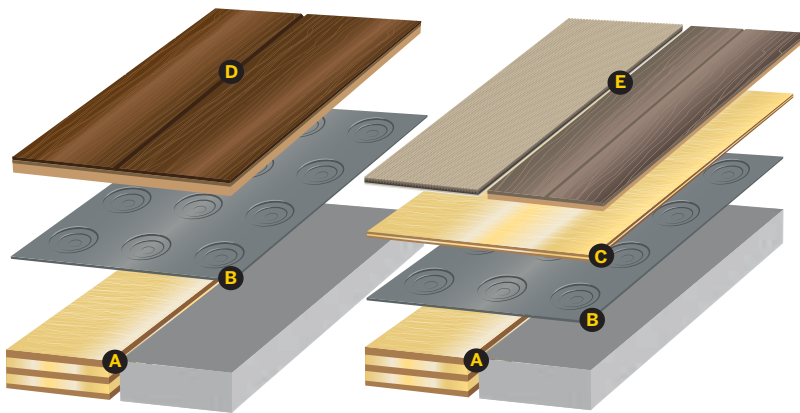

- A. Concrete or plywood substrate
- B.  MULTI-FLOOR®
- C. 5/8" (16 mm) tongue-and-groove plywood
- D. Hardwood or laminate
- E. LVT/LVP or carpet

Profile Number	Dimensions	Color
----------------	------------	-------

MD8010GRY20

215 sq.ft (20 m) roll

Grey



## M-D MULTI-FLOOR® SEALING TAPE

Tape designed to seal all joints between sections of M-D MULTI-FLOOR® underlayment. The tape resists moisture and provides premium bonding capabilities.\*

**PACK SIZE: 6 ROLLS**

Profile Number	Dimensions	Color
----------------	------------	-------

MD8020BLK55

180.4' x 1.9" (55 m x 48 mm)

Black



\* Seal all joints with **M-D MULTI-FLOOR® SEALING TAPE**

**NOTE:** This step is recommended for all applications, but it is required for installations done below grade or on concrete substrates that are above or below grade.

# MARKETING TOOLS

At M-D PRO, we believe that our customers come first and that not only is apparent in the products and care we provide but also in how we aid in future sales of our products at the distributor level. The following section outlines all of the sample materials available for customer use which gives the purchaser the opportunity to see finish/color, feel the product, and choose a profile that is right for their project.





## CHAIN SETS



### MPCHAINSET11

Solid Oak moldings chain set.

PACK SIZE: 1 PC



### MPCHAINSET12

Primed Pine chain set.

PACK SIZE: 1 PC

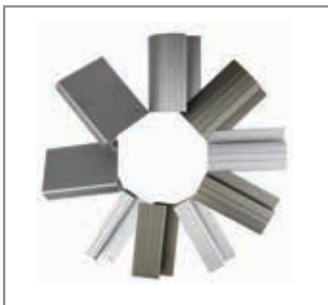

### MPCHAINSETS13

Laminate metal chain set.

PACK SIZE: 1 PC



### MPCHAINSETS15

Wood Grain laminate chain set.

PACK SIZE: 1 PC



### MPCHAINSET27

MDF Profile chain set.

PACK SIZE: 1 PC

## CHAIN SETS



### MPCHAINSET32

Unfinished Wood -  
Oak/Maple chain set.

PACK SIZE: 1 PC



### MPSWATCH614MDF

MDF Wood Grain fan deck.

PACK SIZE: 1 PC

## SAMPLE BOARD



### MPSAMPLEMDF

MDF Sample board.

PACK SIZE: 1 PC

# ORDER POLICIES AND WARRANTY

## MDF LAMINATE

Requests for MDF moldings/trims that fall within our published Special Order (SO) assortment are subject to minimums. The minimum order quantity (MOQ) is dependent on the profile ordered. Please refer to the chart below for minimums.

Profile	MOQ
Quarter Round	50 pieces

\*Please allow a minimum of 15 business days from receipt of PO for shipment.

## BROKEN CARTON POLICY

Less than full cartons may be purchased on select items with a minimum up charge of 20%, please contact your Customer Service Representatives for details. No returns will be granted for items that fall below the standard carton/pack size.

## M-D PRO LIMITED WARRANTY

M-D PRO products are warranted for a period of 1 (one) year from date of shipment. All products will be subject to the following manufacture warranties; Products will conform to original product and contract description with only such reasonable variations as is acceptable in the trade. These products will be fit for the purposes for which they were intended and that they will be professionally packaged and labeled. M-D PRO will replace any defective product found if said defect is identified before installation. If a defect is found after installation, M-D PRO must be notified in writing within 10 days of installation. The customer must then, at M-D PRO's discretion, allow an inspection of the installation. If upon inspection, M-D PRO determines the product to be defective, M-D PRO will at its own discretion supply replacement materials that conform to the contract requirements or issue a credit equal to but not exceeding the original purchase price for the goods in question. M-D PRO assumes no liability or responsibilities for labor or the cost of other materials used in such installations.

These warranties do not circumvent any individual product category warranties implied or stated by M-D PRO.

Warranties do not apply to the following specified items, terms and conditions:

- A.** Exact matching of color, shade, texturing or mottling.
- B.** Any warranties, other than expressed above, implied or promised by any sales representative.
- C.** Tears, scratches, burns, or other damage caused by improper installation, improper use or maintenance.
- D.** Sales of "Seconds", or "Imperfect" goods.
- E.** Problem caused by moisture, hydrostatic pressure or alkali in the sub-floor.
- F.** Problem caused by installation with non-approved adhesive. If you are unsure about the suitability of a particular adhesive, please call us for our recommendations.
- G.** Product installed outdoors. M-D PRO products are designed for interior use only.
- H.** Color degradation caused by sunlight or other U.V. exposure. These warranties are supplied in lieu of any other warranty, expressed or implied. All product specifications are subject to change without notice.



5720 Ambler Drive  
Mississauga, ON, L4W 2B1  
Telephone: 1 800 565 6653  
E-mail: [service@mdteam.com](mailto:service@mdteam.com)  
Website: [www.mdpro.com](http://www.mdpro.com)

Part #: MPCATWOOD  
Print date: July 2022